

HEYCO



PREISLISTE WERKZEUGE 2015 €



PRICE LIST **TOOLS**

LISTE DE PRIX **OUTILS**

LISTA DE PRECIOS **HERRAMIENTAS**

PRIJSLIJST **GEREEDSCHAPPEN**

HEYCO

WERKZEUGE FACHHANDEL
WERKZEUGE AUTOMOBIL
TOOLS FOR THE SPECIALIST TRADE
TOOLS FOR THE AUTOMOTIVE INDUSTRY



HOCHFESTE FORMTEILE
HIGH TENSILE FORMED COMPONENTS



TECHNISCHE
KUNSTSTOFFPRODUKTE
TECHNICAL PLASTIC PRODUCTS



ZERTIFIZIERTES QM SYSTEM
CERTIFIED QM SYSTEMS

ISO 9001

ISO/TS 16949



HAUPTSITZ
UND VERWALTUNG

HEAD OFFICE
AND ADMINISTRATION

HEYCO-WERK
HEYNEN GMBH & CO. KG
BIRGDEN III/1
D-42855 REMSCHEID

☎ +49/(0)2191/205-0

☎ +49/(0)2191/205-266

@ info@heyco.de
<http://www.heyco.de>

ZWEIGNIEDERLASSUNGEN
DEUTSCHLAND

GERMAN BRANCHES

HEYCO-WERK SÜD
D-94104 TITTLING

HEYCO-WERK REMSCHEID
INDUSTRIEGEBIET BERGISCH-BORN
D-42897 REMSCHEID

AUSLANDSGESELLSCHAFTEN

FOREIGN SUBSIDIARIES

HEYCO-WERK IRELAND Ltd.
BALLINA CO. MAYO
REPUBLIC OF IRELAND

HEYCO-WERK ČR s.r.o.
CZ-39701 PISEK
CZECH REPUBLIC

WERKZEUGE 2015 TOOLS 2015

D Abkürzungen, Symbole und Hinweise

ST	00	standardmäßig		Packeinheit
G	05	gesandstrahlt		Länge
A	10	schwarz		Durchmesser
AS	11	schwarz, teilweise geschliffen		auf Katalogseite
ASD	13	schwarz, teilweise geschliffen, Griffe kunststoffbeschichtet		metrische Schlüsselweiten für Schrauben und Muttern mit Außensechskant
L	20	lackiert		amerikanische Zoll-Schlüsselweiten für Schrauben und Muttern mit Außensechskant
LS	21	lackiert, teilweise geschliffen		britische Zoll-Schlüsselweiten für Schrauben und Muttern mit Außensechskant, Maßangaben nach Bolzenstärken
LG	25	lackiert, teilweise gesandstrahlt		metrische Schlüsselweiten für Innensechskantschrauben
B	30	brüniert		amerikanische Zoll-Schlüsselweiten für Innensechskantschrauben
BI	32	brüniert, mit Kunststoffhüllen		Schlüsselweite bei TORX®-Schrauben
BV	33	brüniert, VDE 1000 Volt schutzisoliert		Innensechskant
PH	36	phosphatiert		Innensechskant Schon-Profil
PHS	37	phosphatiert, teilweise geschliffen		Innen-Doppelsechskant
P	40	poliert		Innen-Doppelsechskant Schon-Profil
MS	45	Messing		Innenvierkant
N	50	vernickelt		Außenvierkant
ND	54	vernickelt, Griffe kunststoffbeschichtet		Außensechskant u. für Innensechskantschrauben
NI	55	vernickelt, mit Kunststoffhüllen		für Schlitzschrauben
Z	60	verzinkt, blau chromatiert		für Kreuzschlitzschrauben PHILLIPS-RECESS
K	68	antikorrosive Spezialbeschichtung		für Kreuzschlitzschrauben POZIDRIV®
CL	70	chromfarbig		für Innenvielzahn-Schrauben XZN
C	80	verchromt		für Innenkeilprofil-Schrauben RIBE CV
CP	82	verchromt, teilweise poliert		für Innen-TORX®-Schrauben
CPP	83	verchromt, ganz poliert		für Außen-TORX®-Schrauben
CI	85	verchromt, kunststoffüberzogen		KREUZmix für Kreuzschlitzschrauben PHILLIPS-RECESS + POZIDRIV®
CPI	86	verchromt, Kopf poliert, mit Kunststoffhüllen		
CPD	87	verchromt, Kopf poliert, Griffe kunststoffbeschichtet		
CPV	88	verchromt, Kopf poliert, VDE-Isoliergriffhüllen		

POZIDRIV® eingetragenes Warenzeichen der Firma European Industrial Services Ltd.

TORX® eingetragenes Warenzeichen der Firma CAMCAR/TEXTRON INC.

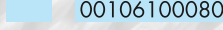
 00106100080 Artikel läuft aus, Lagervorrat vorhanden

Alle Katalogartikel werden technisch ständig optimiert; daher sind Änderungen jederzeit und ohne Ankündigung möglich.

Bitte beachten Sie, daß Tabellenangaben nur in deutscher und englischer Sprache ausgeführt sind. Verkaufs-, Liefer- und Zahlungsbedingungen, alphabetisches Inhaltsverzeichnis siehe gültige Kataloge.

USt.-IdNr.: DE 1208 10068

Unsere Preise sind Grundpreise per Stück/Satz ohne Mehrwertsteuer. Sie sind bei Weiterverkauf durch den Handel als unverbindliche Preisempfehlung anzusehen und nicht zur Weitergabe bestimmt.

Der Nachdruck dieser Preisliste oder von Teilen daraus, die Vervielfältigung, Speicherung und Übermittlung jedweder Art, auch durch Datenverarbeitungsanlagen, sind nur mit unserer schriftlichen Genehmigung gestattet.

GB Abbreviations, symbols and notes

ST	00	standard
G	05	sandblasted
A	10	black
AS	11	black, partly ground
ASD	13	black, partly ground plastic coated handles
L	20	lacquered
LS	21	lacquered, partly ground
LG	25	lacquered, partly sandblasted
B	30	gun-metal finish
BI	32	gun-metal finish, insulated
BV	33	gun-metal finish, VDE 1000 volt insulated
PH	36	phosphated
PHS	37	phosphated, partly ground
P	40	polished
MS	45	brass
N	50	nickel plated
ND	54	nickel plated, plastic coated handles
NI	55	nickel plated, insulated
Z	60	zinc plated, blue chromated
K	68	special anti-corrosive plating
CL	70	chrome coloured
C	80	chrome plated
CP	82	chrome plated, partly polished
CPP	83	chrome plated, fully polished
CI	85	chrome plated, insulated
CPI	86	chrome plated, polished head, insulated
CPD	87	chrome plated, polished head, plastic coated handles
CPV	88	CPV 88 chrome plated, polished head, VDE insulated handles

POZIDRIV® Registered trade mark of European Industrial Services Ltd.

TORX® Registered trade mark of CAMCAR/TEXTRON INC.

All catalogue articles are continuously updated to the latest technical standards. As a result, specifications are subject to change without prior notice.



























Please note, that information in tables has been limited to German and English language. For terms of sale, delivery and payment, the alphabetical index please refer to current catalogues.

VAT Reg. Number: DE 1208 10068

F Abréviations, symboles et indications

	packing unit
	length
	diameter
	on page
	spanner openings in metric for hexagon head screws, bolts and nuts
	spanner openings in inches (American sizes) for hexagon head screws, bolts and nuts
	spanner openings in inches (British sizes) for hexagon head screws, bolts and nuts sizes stated for diameter of bolt
	sizes in metric for hexagon socket screws and bolts
	sizes in inches (American sizes) for hexagon socket screws and bolts
	size in millimetres for TORX®-screws
	inside hexagon
	inside hexagon Schon-Profil (profile saver)
	inside bihexagon
	inside bihexagon – Schon-Profil (profile saver)
	inside square
	outside square
	outside hexagon – for hexagon socket screws
	for plain slot screws
	for cross slot screws PHILLIPS-RECESS
	for cross slot screws POZIDRIV®
	for multi-spline socket screws XZN
	for fluted socket screws RIBE CV
	for TORX®-socket screws
	for TORX®-head screws
	CROSSmix for cross slot screws PHILLIPS-RECESS + POZIDRIV®
	00106100080 production discontinued small stocklots

ST	00	standard
G	05	sablé
A	10	noir
AS	11	noir, partiellement meulé
ASD	13	noir, partiellement poli, branches gainées plastique
L	20	laqué
LS	21	laqué, partiellement meulé
LG	25	laqué, partiellement sablé
B	30	bruni
BI	32	bruni, branches gainées plastique
BV	33	bruni, isolé VDE 1000 volts
PH	36	phosphaté
PHS	37	phosphaté, partiellement meulé
P	40	poli
MS	45	laiton
N	50	nickelé
ND	54	nickelé, branches gainées plastique
NI	55	nickelé, branches gainées plastique
Z	60	galvanisé, bleu passivé
K	68	couche spéciale anticorrosive
CL	70	couleur chrome
C	80	chromé
CP	82	chromé, partiellement poli
CPP	83	chromé, entièrement poli
CI	85	chromé, gainé plastique
CPI	86	chromé, tête polie, branches gainées plastique
CPD	87	chromé, tête polie, branches gainées plastique
CPV	88	chromé, tête polie, branches isolées VDE 1000 volts
POZIDRIV®		marque déposée par la société European Industrial Services Ltd.
TORX®		marque déposée par la société CAMCAR/TEXTRON INC.

	unité d'emballage
	longueur
	diamètre
	page du catalogue
	ouvertures métriques pour vis et écrous hexagonaux
	ouvertures en pouces (dimensions américaines) pour vis et écrous hexagonaux
	ouvertures en pouces (dimensions britanniques) pour vis et écrous hexagonaux, dimensions indiquées pour le diamètre du boulon
	ouvertures métriques pour vis 6 pans creux
	ouvertures en pouces (dimensions américaines) pour vis 6 pans creux
	ouvertures métriques pour vis TORX®
	6 pans intérieur
	6 pans intérieur – profil d'usure
	12 pans intérieur
	12 pans intérieur – profil d'usure
	carré femelle
	carré mâle
	6 pans mâle
	pour vis à fente
	pour vis cruciformes PHILLIPS-RECESS
	pour vis cruciformes POZIDRIV®
	pour vis denture multiple XZN
	pour vis à empreinte à créneaux RIBE CV
	pour vis TORX® intérieures
	pour vis TORX® extérieures
	Cruciforme Mixte pour vis cruciformes PHILLIPS-RECESS + POZIDRIV®
	00106100080 fabrication suspendue petites quantités encore en stock

Our price list contains gross-prices per piece/set, excluding value added tax. They are to be considered as recommended retail prices.

Reprint of this price list or parts thereof, reproduction, storage in retrieval systems, unauthorized utilization and transmission in any form or by any means including computer systems is only permitted with our prior consent in writing.

Les produits du catalogue étant soumis à des améliorations techniques permanentes, le fabricant se réserve le droit de modifier leurs caractéristiques à tout moment et sans préavis.

Veillez noter que les données en tête des tableaux ne sont indiquées qu'en allemand et en anglais. Pour les conditions de vente, de livraison et de paiement, l'index alphabétique veuillez vous référer au catalogue actuel.

N° d'identification intracommunautaire:
DE 1208 10068

Les prix indiqués dans ce catalogue sont des prix de base hors T. V. A. Ils sont donnés à titre indicatif aux revendeurs et ne sont pas destinés à être divulgués.

Toute reproduction, copie ou diffusion, totale ou partielle de ce tarif, par quelque procédé que ce soit, notamment par photocopie ou par équipement informatique, est interdite sans notre autorisation écrite.

E Abreviaturas, símbolos e información

ST	00	estándar		unidad de envase
G	05	granallado		longitud
A	10	negro		diámetro
AS	11	negro, parcialmente pulido		en página
ASD	13	negro, parcialmente pulido, mangos plastificados		medidas métricas para tornillos y tuercas con hexágono exterior
L	20	barnizado		medidas en pulgadas AF para tornillos y tuercas con hexágono exterior
LS	21	barnizado, parcialmente pulido		medidas en pulgadas Whitworth para tornillos y tuercas con hexágono exterior, medidas referentes al grosor del bulón
LG	25	barnizado, parcialmente granallado		medidas métricas para tornillos con hexágono interior
B	30	pavonado		medidas en pulgadas AF para tornillos con hexágono interior
BI	32	pavonado, con fundas de plástico		medidas para tornillos TORX®
BV	33	pavonado, aislado VDE 1000 V		hexágono interior
PH	36	fosfatado		hexágono interior, perfil protector
PHS	37	fosfatado, parcialmente amolado		estrella interior
P	40	pulido		estrella interior, perfil protector
MS	45	latonado		cuadradillo interior
N	50	niquelado		cuadradillo exterior
ND	54	niquelado, mangos plastificados		hexágono exterior
NI	55	niquelado, con fundas de plástico		para tornillos ranurados
Z	60	cincado, cromatizado azul		para tornillos PHILLIPS-RECESS
K	68	recubrimiento especial anticorrosivo		para tornillos POZIDRIV®
CL	70	cromatizado		para tornillos XZN
C	80	cromado		para tornillos RIBE CV
CP	82	cromado, parcialmente pulido espejo		para tornillos TORX® interiores
CPP	83	cromado, enteramente pulido espejo		para tornillos TORX® exteriores
CI	85	cromado, plastificado		CRUZmix para tornillos PHILLIPS-RECESS + POZIDRIV®
CPI	86	cromado, cabeza pulida, con fundas de plástico		
CPD	87	cromado, cabeza pulida, mangos plastificados		
CPV	88	cromado, cabeza pulida, aislado VDE 1000 V		

POZIDRIV® marca registrada de European Industrial Services Ltd.

TORX® marca registrada de CAMCAR/TEXTRON INC.

Todos los artículos del catálogo están sometidos a perfeccionamiento continuo. Por eso, están sujetos a posibles modificaciones sin previo aviso.

Observen que los datos contenidos en las tablas están solamente en alemán e inglés. Para condiciones de venta, envío y pago, índice alfabético véanse catálogos en vigor.

N ° de identificación fiscal: DE 1208 10068.

El presente catálogo – tarifa refleja precios de venta al público recomendados, por pieza/juego, I.V.A. no incluido.

La reproducción íntegra o parcial de este catálogo, su copia, registro o retransmisión de cualquier tipo, incluso por medios informáticos, requieren obligatoriamente nuestra autorización escrita.

 00106100080 artículo fuera de programa, disponible salvo venta

NL Afkortingen, symbolen en verwijzingen

ST	00	standaarduitvoering
G	05	gezandstraald
A	10	zwart
AS	11	zwart, gedeeltelijk geslepen
ASD	13	zwart, gedeeltelijk geslepen Grepn kunststofgedompeld
L	20	gelakt
LS	21	gelakt, gedeeltelijk geslepen
LG	25	gelakt, gedeeltelijk gezandstraald
B	30	gebruineerd
BI	32	gebruineerd, met kunststof omhulsel
BV	33	gebruineerd, VDE 1000 Volt geïsoleerd
PH	36	gefosfateerd
PHS	37	gefosfateerd, gedeeltelijk geslepen
P	40	gepolijst
MS	45	messing
N	50	vernikkeld
ND	54	vernikkeld, Grepn kunststofgedompeld
NI	55	vernikkeld, met kunststof omhulsel
Z	60	verzinkt, blauw gechrommeerd
K	68	speciale anti-roest-behandeling
CL	70	chromkleurig
C	80	verchromd
CP	82	verchromd, gedeeltelijk gepolijst
CPP	83	verchromd, geheel gepolijst
CI	85	verchromd, met kunststof overtrokken
CPI	86	verchromd, gepolijste kop, met kunststof omhulsel
CPD	87	verchromd, gepolijste kop, Grepn kunststofgedompeld
CPV	88	verchromd, gepolijste kop, VDE 1000 Volt geïsoleerd
POZIDRIV®		gedeponeerd handelsmerk van de firma European Industrial Services Ltd.
TORX®		gedeponeerd handelsmerk van de firma CAMCAR/TEXTRON INC.

Alle artikelen in deze catalogus worden in technisch opzicht voortdurend verbeterd; daarom zijn wijzigingen te allen tijd en zonder aanzegging mogelijk.

Gelieve er nota van te nemen dat de vermeldingen in de tabellen uitsluitend in de Duitse en Engelse taal zijn. Voor de verkoop - leverings- en betalings- condities, alfabetische inhoudsopgave zie de actuele catalogus.

HEYCO-BTW-Nr.: DE 1208 10068

	verpakkingseenheid
	lengte
	diameter
	op bladzijde
	metrische sleutelwijdte voor bouten en moeren met buitenzeskant
	sleutelwijdte in Amerikaanse maat voor bouten en moeren met buitenzeskant
	sleutelwijdte in Engelse maat voor bouten en moeren met buitenzeskant met maataanduiding volgens schroefdraad Ø
	metrische sleutelwijdte voor binnenzeskant-bouten
	sleutelwijdte in Amerikaanse maat voor binnenzeskant-bouten
	sleutelwijdte bij TORX®-bouten
	binnenzeskant
	binnenzeskant – beschermprofiel
	binnentwaalfkant
	binnentwaalfkant – beschermprofiel
	binnenvierkant
	buitenvierkant
	buitenzeskant
	voor sleufschroeven
	voor kruiskopschroeven PHILLIPS-RECESS
	voor kruiskopschroeven POZIDRIV®
	voor binnenveltdandbouten XZN
	voor spiebaanbouten RIBE CV
	voor binnen-TORX®-schroeven
	voor buiten-TORX®-schroeven
	KRUISmix voor kruiskopschroeven PHILLIPS-RECESS + POZIDRIV®
	00106100080 uitloopartikel, nog voorraad aanwezig

Onze catalogusprijzen zijn basis-prijzen per stuk/sets zonder BTW. Deze dienen bij doorverkoop door de handel beschouwd te worden als adviesprijzen.

Nadruk van deze catalogus of delen ervan, vermenigvuldiging, opslag en overdracht van welke aard dan ook, ook door gegevensverwerkende installaties, zijn alleen toegestaan met onze schriftelijke toestemming.

FIN Lyhenteet, symbolit ja merkinnät

ST	00	vakio		pakkkaus
G	05	hiekkapuhallettu		pituus
A	10	musta		halkaisija
AS	11	musta, osittain hiottu		sivunumero
ASD	13	musta, osittain hiottu, muovipäällystetyt kädensijat		avainväli metrimitoitetuille kuusiokantaisille ruuveille, pulteille ja muttereille
L	20	lakattu		avainväli tuumamitoitetuille (amerikkalaiset) kuusiokantaisille ruuveille, pulteille ja muttereille
LS	21	lakattu, osittain hiottu		avainväli tuumamitoitetuille (brittiläiset) kuusiokantaisille ruuveille, pulteille ja muttereille
LG	25	lakattu, osittain hiekkapuhallettu		metrimitoitetut koot kuusiokoloruuveille ja -muttereille
B	30	asetmetalli viimeistely		tuumamitoitetut koot (amerikkalaiset) kuusiokoloruuveille ja -muttereille
BI	32	asetmetalli viimeistely, eristetty		TORX®-ruuveille
BV	33	asetmetalli viimeistely, VDE 1000 voltin eristys		sisäpuolinen kuusiokanta
PH	36	fosfatoitu		sisäpuolinen kuusiokanta, profiilin säästäjä
PHS	37	fosfatoitu, osittain hiottu		12-kulmainen
P	40	kiillotettu		12-kulmainen, profiilin säästäjä
MS	45	messinki		sisäpuolinen neliö
N	50	nikkelöity		ulkopuolinen neliö
ND	54	nikkelöity, muovipäällystetyt kädensijat		ulkopuolinen kuusio
NI	55	nikkelöity, eristetty		suorauraruuveille
Z	60	sinkitty, sinikromattu		PHILLIPS-RECESS-ristipääruuveille
K	68	erikoiskorroosionesto pinnoitus		POZIDRIV®-ristipääruuveille
CL	70	kromivärjäys		XZN-ruuveille
C	80	kromipinnoitus		RIBE CV-ruuveille
CP	82	kromipinnoitus, osittain kiillotettu		TORX®-sisäpuolinen
CPP	83	kromipinnoitus, kokonaan kiillotettu		TORX®-ulkopuolinen
CI	85	kromipinnoitus, eristetty		Yhdistelmäkätki PHILLIPS-RECESS + POZIDRIV®
CPI	86	kromipinnoitus, kiillotettu pää, eristetty		00106100080 tuotannosta poistuva tuote
CPD	87	kromipinnoitus, kiillotettu pää, muovipäällystetyt kädensijat		
CPV	88	kromipinnoitus, kiillotettu pää, VDE-eristetyt kädensijat		
POZIDRIV®		rekisteröity tavaramerkki European Industrial Services Ltd.		
TORX®		rekisteröity tavaramerkki CAMCAR/TEXTRON INC.		

Kaikki tuoteluettelon tuotteet päivitetään jatkuvasti viimeisimpien teknisten standardien mukaiseksi. Tuotteita voidaan muuttaa ilman erillistä ilmoitusta.

Huomioikaa, että taulukotiedot ovat vain saksaksi ja englanniksi. Myynti-, toimitus- ja maksuehdot sekä aakkoshakemiston pyydämme katsomaan uusimmasta kuvastosta.

VAT tunnus: DE 1208 10068

Tuoteluettelon hinnat ovat ilman arvonlisäveroa. Hinnat ovat myyntihintoja täysin pakkauksin.

Tämän tuoteluettelon tai sen osien jäljentäminen, muuntaminen, valtuuttamaton hyväksikäyttö, luovuttaminen missään muodossa, mukaan lukien tietotekniset mahdollisuudet ei ole sallittua ilman antamaamme kirjallista lupaa.

Zoll / mm AF / mm

1 Zoll = 25,3995 mm

Zoll	1"	2"	3"	4"	5"	6"	7"	8"	9"	10"	11"	12"	13"	14"	15"	Zoll	
	mm	25,3995	50,7990	76,1986	101,598	126,998	152,397	177,797	203,196	228,596	253,995	279,395	304,794	330,194	355,594	380,994	
1/64	0,3968	25,7964	51,1959	76,5954	101,995	127,394	152,794	178,193	203,593	228,992	254,392	279,792	305,191	330,591	355,991	381,391	1/64
1/32	0,7937	26,1932	51,5928	76,9923	102,391	127,791	153,190	178,590	203,990	229,389	254,789	280,189	305,588	330,988	356,388	381,788	1/32
3/64	1,1906	26,5901	51,9896	77,3892	102,788	128,188	153,588	178,987	204,386	229,786	255,186	280,586	305,985	331,385	356,785	382,185	3/64
1/16	1,5874	26,9870	52,3865	77,7860	103,185	128,585	153,984	179,384	204,783	230,183	255,582	280,982	306,381	331,781	357,181	382,581	1/16
5/64	1,9843	27,3838	52,7834	78,1829	103,582	128,982	154,381	179,781	205,180	230,580	255,979	281,379	306,778	332,178	357,578	382,978	5/64
3/32	2,3812	27,7807	53,1802	78,5798	103,979	129,378	154,778	180,177	205,577	230,977	256,376	281,776	307,175	332,575	357,975	383,375	3/32
7/64	2,7780	28,1776	53,5771	78,9766	104,376	129,775	155,175	180,574	205,974	231,373	256,773	282,173	307,572	332,972	358,372	383,772	7/64
1/8	3,1749	28,5744	53,9740	79,3735	104,773	130,172	155,572	180,971	206,370	231,770	257,170	282,570	307,969	333,369	358,769	384,169	1/8
9/64	3,5718	28,9713	54,3708	79,7704	105,169	130,569	155,969	181,368	206,768	232,167	257,567	282,967	308,366	333,766	359,166	384,566	9/64
5/32	3,9686	29,3682	54,7677	80,1672	105,566	130,966	156,365	181,765	207,164	232,564	257,964	283,364	308,763	334,163	359,563	384,963	5/32
11/64	4,3655	29,7650	55,1646	80,5641	105,963	131,363	156,762	182,162	207,561	232,961	258,360	283,760	309,160	334,560	359,960	385,360	11/64
3/16	4,7624	30,1619	55,5614	80,9610	106,360	131,760	157,159	182,559	207,958	233,358	258,757	284,157	309,556	334,956	360,356	385,756	3/16
13/64	5,1592	30,5588	55,9583	81,3579	106,757	132,156	157,556	182,956	208,355	233,755	259,154	284,554	309,953	335,353	360,753	386,153	13/64
7/32	5,5561	30,9556	56,3552	81,7547	107,154	132,553	157,953	183,352	208,752	234,152	259,551	284,951	310,350	335,750	361,150	386,550	7/32
15/64	5,9530	31,3525	56,7520	82,1516	107,551	132,950	158,350	183,749	209,149	234,548	259,948	285,348	310,747	336,147	361,547	386,947	15/64
1/4	6,3498	31,7494	57,1489	82,5485	107,948	133,347	158,747	184,146	209,546	234,945	260,345	285,745	311,144	336,544	361,944	387,344	1/4
17/64	6,7467	32,1462	57,5458	82,9453	108,344	133,744	159,143	184,543	209,943	235,342	260,742	286,142	311,541	336,941	362,341	387,741	17/64
9/32	7,1436	32,5431	57,9426	83,3422	108,741	134,141	159,540	184,940	210,339	235,739	261,139	286,539	311,938	337,338	362,738	388,138	9/32
19/64	7,5404	32,9400	58,3395	83,7391	109,138	134,538	159,937	185,337	210,736	236,136	261,535	286,935	312,334	337,734	363,134	388,534	19/64
5/16	7,9373	33,3368	58,7364	84,1359	109,535	134,935	160,334	185,734	211,133	236,532	261,932	287,332	312,731	338,131	363,531	388,931	5/16
21/64	8,3342	33,7337	59,1333	84,5328	109,932	135,331	160,731	186,131	211,530	236,930	262,329	287,729	313,128	338,528	363,928	389,328	21/64
11/32	8,7310	34,1306	59,5301	84,9297	110,329	135,728	161,128	186,527	211,927	237,326	262,726	288,126	313,525	338,925	364,325	389,725	11/32
23/64	9,1279	34,5274	59,9270	85,3265	110,726	136,125	161,525	186,924	212,324	237,723	263,123	288,523	313,922	339,322	364,722	390,122	23/64
3/8	9,5248	34,9243	60,3239	85,7234	111,122	136,522	161,922	187,321	212,721	238,120	263,520	288,920	314,319	339,719	365,119	390,519	3/8
25/64	9,9217	35,3212	60,7207	86,1203	111,529	136,919	162,318	187,718	213,118	238,517	263,917	289,317	314,716	340,116	365,516	390,916	25/64
13/32	10,3185	35,7180	61,1176	86,5171	111,916	137,316	162,715	188,115	213,514	238,914	264,313	289,712	315,113	340,513	365,913	391,313	13/32
27/64	10,7154	36,1149	61,5145	86,9140	112,313	137,713	163,112	188,512	213,911	239,311	264,710	290,110	315,509	340,909	366,309	391,709	27/64
7/16	11,1122	36,5118	61,9113	87,3109	112,710	138,109	163,509	188,909	214,308	239,708	265,107	290,507	315,906	341,306	366,706	392,106	7/16
29/64	11,5091	36,9087	62,3082	87,7077	113,107	138,506	163,906	189,305	214,705	240,105	265,504	290,904	316,303	341,703	367,103	392,503	29/64
15/32	11,9060	37,3055	62,7051	88,1046	113,504	138,903	164,303	189,702	215,102	240,501	265,901	291,301	316,700	342,100	367,500	392,900	15/32
31/64	12,3029	37,7024	63,1019	88,5015	113,901	139,300	164,700	190,099	215,499	240,898	266,298	291,698	317,097	342,497	367,897	393,297	31/64
1/2	12,6997	38,0993	63,4988	88,8983	114,297	139,697	165,097	190,496	215,896	241,295	266,695	292,095	317,494	342,894	368,294	393,694	1/2
33/64	13,0966	38,4951	63,8957	89,2952	114,694	140,094	165,493	190,893	216,292	241,692	267,092	292,492	317,891	343,291	368,691	394,091	33/64
17/32	13,4934	38,8930	64,2925	89,6921	115,091	140,491	165,890	191,290	216,689	242,089	267,488	292,888	318,287	343,687	369,087	394,487	17/32
35/64	13,8903	39,2899	64,6894	90,0898	115,489	140,888	166,287	191,687	217,086	242,486	267,885	293,285	318,684	344,084	369,484	394,884	35/64
9/16	14,2872	39,6867	65,0863	90,4858	115,885	141,284	166,684	192,084	217,483	242,883	268,282	293,682	319,081	344,481	369,881	395,281	9/16
37/64	14,6841	40,0836	65,4831	90,8827	116,282	141,681	167,081	192,480	217,880	243,279	268,679	294,079	319,478	344,878	370,278	395,678	37/64
19/32	15,0809	40,4805	65,8800	91,2795	116,679	142,078	167,478	192,877	218,277	243,676	269,076	294,476	319,875	345,275	370,675	396,075	19/32
39/64	15,4778	40,8773	66,2769	91,6764	117,075	142,475	167,875	193,274	218,674	244,073	269,473	294,873	320,272	345,672	371,072	396,472	39/64
5/8	15,8747	41,2742	66,6739	92,0733	117,472	142,872	168,271	193,671	219,071	244,470	269,870	295,270	320,669	346,069	371,469	396,869	5/8
41/64	16,2715	41,6711	67,0706	92,4701	117,869	143,269	168,668	194,068	219,467	244,867	270,266	295,666	321,066	346,466	371,866	397,266	41/64
21/32	16,6684	42,0679	67,4675	92,8670	118,266	143,666	169,065	194,464	219,864	245,263	270,663	296,063	321,462	346,862	372,262	397,662	21/32
43/64	17,0653	42,4648	67,8643	93,2639	118,663	144,063	169,462	194,862	220,261	245,661	271,060	296,460	321,859	347,259	372,659	398,059	43/64
11/16	17,4621	42,8617	68,2612	93,6608	119,060	144,459	169,859	195,258	220,658	246,058	271,457	296,857	322,256	347,656	373,056	398,456	11/16
45/64	17,8590	43,2585	68,6581	94,0576	119,457	144,856	170,256	195,655	221,055	246,454	271,854	297,254	322,653	348,053	373,453	398,853	45/64
23/32	18,2559	43,6554	69,0549	94,4545	119,854	145,253	170,653	196,052	221,452	246,851	272,251	297,651	323,050	348,450	373,850	399,250	23/32
47/64	18,6527	44,0523	69,4518	94,8513	120,250	145,650	171,050	196,449	221,849	247,248	272,648	298,048	323,447	348,847	374,247	399,647	47/64
3/4	19,0496	44,4491	69,8487	95,2482	120,647	146,047	171,446	196,846	222,245	247,645	273,045	298,445	323,844	349,244	374,644	400,044	3/4
49/64	19,4465	44,8460	70,2455	95,6451	121,044	146,444	171,843	197,243	222,642	248,042	273,441	298,841	324,241	349,641	375,041	400,441	49/64
25/32	19,8433	45,2429	70,6424	96,0419	121,441	146,841	172,240	197,640	223,039	248,439	273,838	299,238	324,637	350,037	375,437	400,837	25/32
51/64	20,2402	45,6397	71,0393	96,4398	121,838	147,237	172,637	198,037	223,4								

HEYCO

Programmerweiterung
Additions to Product Range

2015





1128

Werkstattwagen
Workshop Trolley

Verbessertes Modell
Modified model

Seite Page
43/44/45



Abmessungen: ca. 886 x 511 x 850 mm aus Stahlblech
Korpus grau - Schubladen schwarz
Dimensions: approx. 886 x 511 x 850 mm from sheet steel
Body grey - drawers black
Verriegelung durch Zylinderschloss
Locking by cylinder lock
Mit ABS-Arbeitsplatte
With ABS work top

- 7 Schubladen /drawers
- ① 3 Schubladen /drawers ca./approx. 564 x 415 x 54 mm
 - ② 2 Schubfach /drawer ca./approx. 564 x 415 x 72 mm
 - ③ 1 Schubfach /drawer ca./approx. 564 x 415 x 176 mm
 - ④ 1 Schubfach /drawer ca./approx. 310 x 435 x 75 mm

2 Lenkrollen /2 steering rollers
2 Feststellrollen /2 castors

ca. 30 kg Belastbarkeit pro Schubfach,
Leergewicht ca. 55 kg
approx. 30 kg loading capacity for each drawer,
weight empty approx. 55 kg



40-18-1/2

Zündkerzeneinsätze, extra lang **Neu** Spark Plug Sockets, extra long **New**

Seite Page
22

Bestell-No. 
Order-No.

00040180183	14
00040180283	16

←L→
mm

250

3/8"

Chrom-Vanadium
CP = verchromt,
teilweise poliert

Chrome-Vanadium
CP = chromium plated,
partly polished

- Extra long, 250 mm
- Besonders gut geeignet für extrem tiefsitzende Kerzen
- Kreuzrändelung für mehr Grip
- Extra long, 250 mm
- Best suited for extremely deep mounted spark/glow plug sockets
- Cross knurling provides better grip

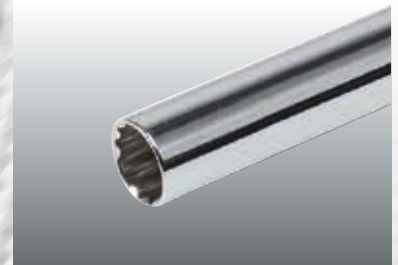
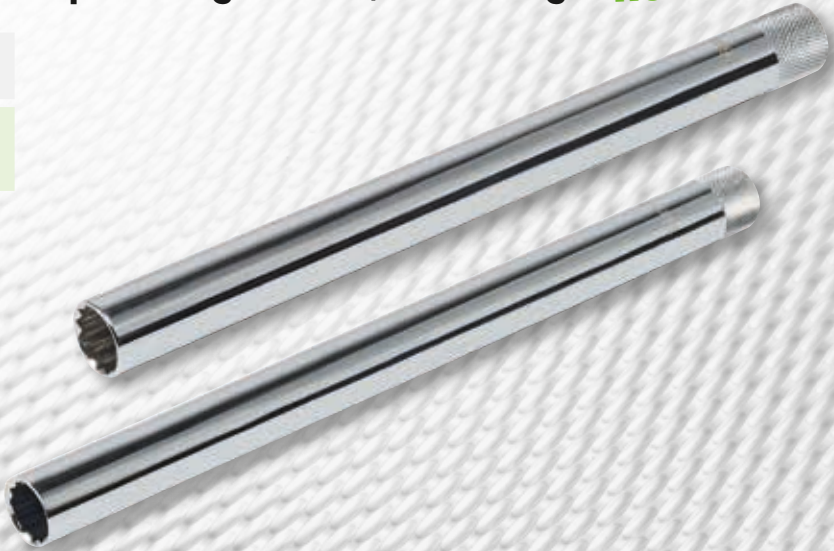

40-17-1/2

Glühkerzeneinsätze mit Gelenk **Neu** Glow Plug Sockets with Joint **New**

Seite Page
22

Bestell-No. 
Order-No.

00040170183	8
00040170283	10

←L→
mm

160 (55/95)

3/8"

Chrom-Vanadium
C = verchromt

Chrome-Vanadium
C = chromium plated

- Mit geschraubtem Kardangelenk
- Ideal für enge Bauräume
- Mit Gummieinsatz zum Halten der losen Glühkerze
- Länge: 160 mm
- With bolted universal joint
- Ideal for restricted locations
- With rubber insert to hold the loose glow plug
- Length: 160 mm

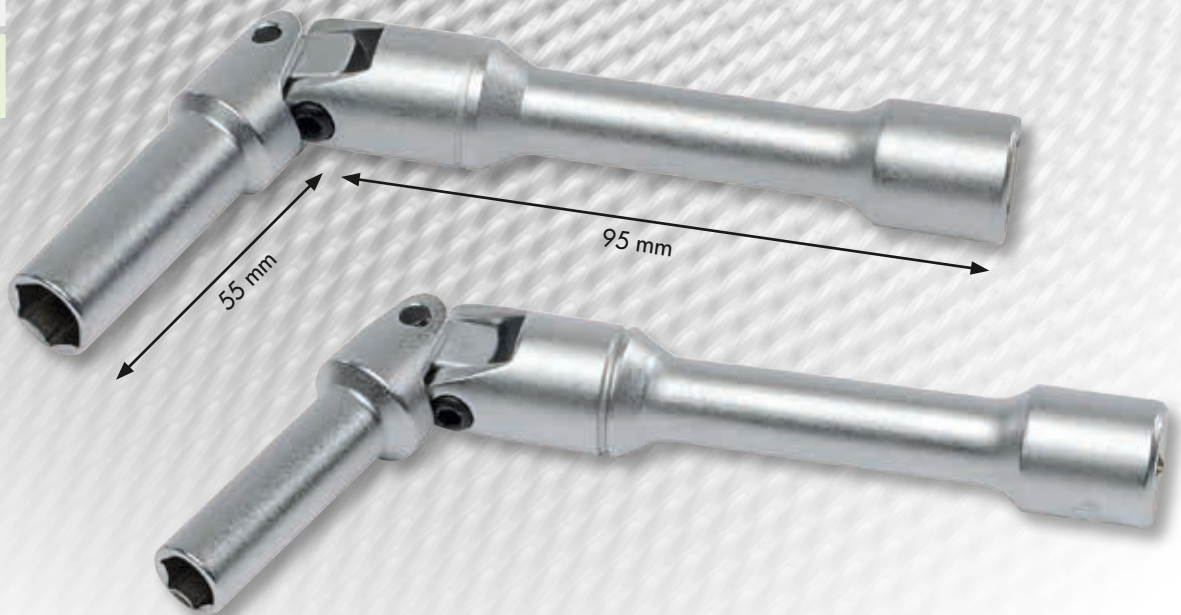

531 **Neu** Werkzeugsatz für die Bremsflüssigkeitsentnahme **New** Tool Set for Brake Fluid Extraction

Bestell-No.
Order-No.

00531010080

enthaltend/containing

Bestell-No. Order-No.	Ø MM	← L → mm
00531700080	7	48
00531800080	8	48
00531900080	9	48
00531100080	10	48
00531110080	11	48
00531907080	7	124
00531908080	8	124
00531909080	9	124
00531910080	10	124
00531911080	11	124

L: 225 mm
B: 115 mm
H: 40 mm



- Ermöglicht das Öffnen und Schließen des Entnahmepipels an der Radbremse auf engstem Raum
- Der integrierte Tropfstopf verhindert das Auslaufen der Bremsflüssigkeit nach dem Abziehen des Rohrschlüssels
- Erhebliche Zeitersparung beim Wechsel der Bremsflüssigkeit und Entlüften des Bremsystems

- Allows for opening and shutting of the drain nipple on the wheel brake in confined spaces
- The integrated drip stop prevents leakage of brake fluid after removal of the pipe wrench
- Considerable saving of time when changing brake fluid or venting the brake system



531-5-1 **Neu** Entnahmebehälter für Bremsflüssigkeit (1 Schlauch), 1,3 L **New** Draining Container for Brake Fluid (1 Tube), 1,3 L

Seite Page
38

Bestell-No.
Order-No.

00531511300



- Glasfaserverstärkter Kunststoff
- Schlagfest
- 1,3 L Fassungsvermögen
- Eingebautes Rückschlagventil
- Transparenter Silikonschlauch, hochflexibel
- Temperaturunempfindlich
- Aufhängemöglichkeit am Fahrzeug
- Eingebaute Zugentlastung
- Korrosionsbeständige Verschraubungen
- Verschlusskappe
- Durchsichtiger Behälter mit Füllstandsanzeige in ml
- Geschlossenes 1-Schlauch-System zur Entnahme an einem Rad

- Glass-Fibre reinforced plastic
- Impact-Proof
- Capacity 1.3 l
- Built-In check valve
- Transparent silicon tube, highly flexible
- Temperature-Immune
- Hanger for use on vehicles
- Built-In strain relief
- Corrosion-Proof fittings
- Closing cap
- Transparent container with level indicator (ml)
- Closed 1-Tube-System for fluid abstraction on one wheel



531-5-2 **Neu** Entnahmebehälter für Bremsflüssigkeit (2 Schläuche), 1,3 L **New** Draining Container for Brake Fluid (2 Tubes), 1,3 L

Seite Page
39

Bestell-No.
Order-No.

00531521300

- Glasfaserverstärkter Kunststoff
- Schlagfest
- 1,3 L Fassungsvermögen
- Eingebautes Rückschlagventil
- Transparenter Silikonschlauch, hochflexibel
- Temperaturunempfindlich
- Aufhängemöglichkeit am Fahrzeug
- Eingebaute Zugentlastung
- Korrosionsbeständige Verschraubungen
- Verschlusskappe
- Durchsichtiger Behälter mit Füllstandsanzeige in ml
- Geschlossenes 2-Schlauch-System zur Entnahme an zwei Rädern gleichzeitig

- Glass-Fibre reinforced plastic
- Impact-Proof
- Capacity 1.3 l
- Built-In check valve
- Transparent silicon tube, highly flexible
- Temperature-Immune
- Hanger for use on vehicles
- Built-In strain relief
- Corrosion-Proof fittings
- Closing cap
- Transparent container with level indicator (ml)
- Closed 2-Tube-System for fluid abstraction on two wheels simultaneously

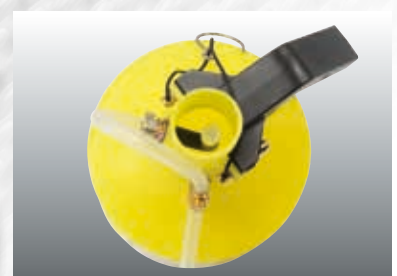

1000-914-M

**Werkzeugsortiment im Werkzeugkasten, 100-tlg.
Mechanics' Tool Set, 100-pcs.**

**Neu
New**

Seite Page
40

Bestell-No.
Order-No.

01000091482

Kfz = Werkstatt Wartung
Motor Mechanic Work-
shop and Maintenance



01000010020 Leerer Werkzeugkasten
00390000882 Verstellbarer Einmaulschlüssel 8" / 205 mm
00370524050 Magnetschlüsselsatz 4 - 7,5 mm
475 Doppelringschlüssel: 6x7/8x9/10x11/12x13/14x15/16x17/
18x19/20x22/21x23/24x26/25x28/27x32 mm
01500050080 Montiereisen 500 mm
01555020021 Flachmeißel 200 x 25 mm
01560015021 Kreuzmeißel 150 x 6 mm
01570000221 Durchreiber 120 / 2 mm
01575000421 Körner 120 / 4 mm
01280025050 Universal-Gripzange 250 mm
00050190182 Zündkerzeneinsatz 20,8 mm
01445004080 Vergaser Schraubendreher 25 x 4
01430015080 Schraubendreher für Schlitzschrauben 150 x 8
01430020080 Schraubendreher für Schlitzschrauben 200 x 10
1411 Kreuzschlitzschraubendreher No. 01 / 1 / 2 "Phillips"
Stackschlüsselsatz 1/2": 10,11,12,13,14,15,16,17,
18,19,20,21,22,23,24,26,27,28,30,32
50-12
00050020083 Kurbel 1/2"
00050080083 Gelenkgriff 1/2"
00050030083 Griff mit Gleitstück 1/2"
00050010083 Hebelumschaltknarre 1/2"
50-04/05 Verlängerung 1/2" 125/250 mm
00050060083 Kardangelen 1/2"
01213016086 Seitenschneider 160 mm
01200018086 Kombinationszange 180 mm
02165003500 Kunststoffhammer Ø 35 mm
01340524030 6-Kant Winkelschraubendreher 2-10 mm
01675020000 Flachstump-Feile 200 mm
01679020000 Rund-Feile 200 mm
01677020000 Dreikant-Feile 200 mm
01686000130 Kontakt-Feile 150 mm
01755000400 Drahtbürste 4-reihig
01520050021 Schlosserhammer 500 gr.
01814000240 Fühlerlehre 13-tlg. 0.05-1.0 mm
01840500000 Profi-Bandmaß 5 m
01782025000 Ölspritzkanne 250 ccm
02199004045 Vorhängeschloss 40 mm
01610000080 Metallsäge, verstellbar
00300024086 Rohr- und Wasserpumpenzange 240 mm
350 Doppelmaulschlüssel: 6x7/8x9/10x11/12x13/14x15/
16x17/18x19/20x22/21x23/24x26/25x28/27x32 mm

Empty Tool Box
Adjustable Wrench 8" / 205 mm
Ignition Wrench Set 4 - 7,5 mm
D.E. Ring Wrench Set: 6x7/8x9/10x11/12x13/14x15/16x17/
18x19/20x22/21x23/24x26/25x28/27x32 mm
Tyre Lever 500 mm
Flat Cold Chisel 200 x 25 mm
Cross Cut Chisel 150 x 6 mm
Drift Punch 120 / 2 mm
Centre Punch 120 / 4 mm
Universal Grip Plier 250 mm
Sparg Plug Socket 20,8 mm
Stubby Screwdriver 25 x 4
Slot Screwdriver 150 x 8
Slot Screwdriver 200 x 10
Crosstail Screwdriver No. 01 / 1 / 2 "Phillips"
Socket 1/2" 10,11,12,13,14,15,16,17,
18,19,20,21,22,23,24,26,27,28,30,32
Speed Brace 1/2"
Swivel Handle 1/2"
Sliding T-Handle 1/2"
Reversible Ratchet 1/2"
Extension Bar 1/2" 125/250 mm
Universal Joint 1/2"
Diagonal Side Cutting Nipper 160 mm
Combination Plier 180 mm
Plastic Hammer Ø 35 mm
Hexagonal Head Wrench Set 2-10 mm
Engineers Hand File 200 mm
Round File 200 mm
Threesquare File 200 mm
Contact File 150 mm
Wire Brush 4-rows
Engineers Hammer 500 gr.
Feeler Gauge 13-pcs. 0.05-1.0 mm
Professional Measuring Tape 5 m
Oil Can 250 ccm
Padlock 40 mm
Adj. Hacksaw Frame
Universal Plier, 240 mm
Double Ended Open Jaw Wrench: 6x7/8x9/10x11/12x13/14x15/
16x17/18x19/20x22/21x23/24x26/25x28/27x32 mm

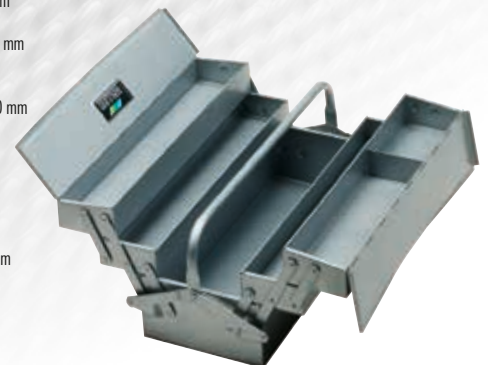

1000-915-M

**Werkzeugsortiment im Werkzeugkasten, 100-tlg.
Mechanics' Tool Set, 100-pcs.**

**Neu
New**

Seite Page
40

Bestell-No.
Order-No.

01000091582

KfZ = Werkstatt Wartung
Motor Mechanic Work-
shop and Maintenance



01000010020 Leerer Werkzeugkasten
00390000882 Verstellbarer Einmaulschlüssel 8" / 205 mm
00370524050 Magnetschlüsselsatz 4 - 7,5 mm
400 Ringmaulschlüssel: 6,7,8,9,10,11,12,13,14,15,
16,17,18,19,20,21,22,23,24,25,26,27,28,32 mm
01500050080 Montiereisen 500 mm
01555020021 Flachmeißel 200 x 25 mm
01560015021 Kreuzmeißel 150 x 6 mm
01570000221 Durchtreiber 120 / 2 mm
01575000421 Körner 120 / 4 mm
01280025050 Universal-Gripzange 250 mm
00050190182 Zündkerzeneinsatz 20,8 mm
01445004080 Vergaser Schraubendreher 25 x 4
01430015080 Schraubendreher für Schlitzschrauben 150 x 8
01430020080 Schraubendreher für Schlitzschrauben 200 x 10
1411 Kreuzschlitzschraubendreher No. 01 / 1 / 2 "Phillips"
50-12 Steckschlüsseleinsätze 1/2": 10,11,12,13,14,15,16,17,
18,19,20,21,22,23,24,26,27,28,30,32 mm
00050020083 Kurbel 1/2"
00050080083 Gelenkgriff 1/2"
00050030083 Griff mit Gleitstück 1/2"
00050010083 Hebelumschaltknarre 1/2"
50-04/05 Verlängerung 1/2" 125/250 mm
00050060083 Kardangelenke 1/2"
01213016086 Seitenschneider 160 mm
01200018086 Kombinationszange 180 mm
02165003500 Kunststoffhammer Ø 35 mm
01340524030 6-Kant Winkelschraubendrehersatz 2-10 mm
01675020000 Flachstumpf-Feile 200 mm
01679020000 Rund-Feile 200 mm
01677020000 Dreikant-Feile 200 mm
01686000130 Kontakt-Feile 150 mm
01755000400 Drahtbürste 4-reihig
01520050021 Schlosserhammer 500 gr.
01814000240 Fühlerlehre 13-tlg. 0.05-1.0 mm
01840500000 Profi-Bandmaß 5 m
01782025000 Ölspritzkanne 250 ccm
02199004045 Vorhängeschloss 40 mm
01610000080 Metallsäge, verstellbar
00300024086 Rohr- und Wasserpumpenzange 240 mm

Empty Tool Box
Adjustable Wrench 8" / 205 mm
Ignition Wrench Set 4 - 7,5 mm
Combination Wrenches: 6,7,8,9,10,11,12,13,14,15,
16,17,18,19,20,21,22,23,24,25,26,27,28,32 mm
Tyre Lever 500 mm
Flat Cold Chisel 200 x 25 mm
Cross Cut Chisel 150 x 6 mm
Drift Punch 120 / 2 mm
Centre Punch 120 / 4 mm
Universal Grip Plier 250 mm
Sparg Plug Socket 20,8 mm
Stubby Screwdriver 25 x 4
Slot Screwdriver 150 x 8
Slot Screwdriver 200 x 10
Crosst Slot Screwdriver No. 01 / 1 / 2 "Phillips"
Sockets 1/2": 10,11,12,13,14,15,16,17,
18,19,20,21,22,23,24,26,27,28,30,32 mm
Speed Brace 1/2"
Swivel Handle 1/2"
Sliding T-Handle 1/2"
Reversible Ratchet 1/2"
Extension Bar 1/2" 125/250 mm
Universal Joint 1/2"
Diagonal Side Cutting Nipper 160 mm
Combination Plier 180 mm
Plastic Hammer Ø 35 mm
Hexagonal Head Wrench Set 2-10 mm
Engineers Hand File 200 mm
Round File 200 mm
Threesquare File 200 mm
Contact File 150 mm
Wire Brush 4-rows
Engineers Hammer 500 gr.
Feeler Gauge 13-pcs. 0.05-1.0 mm
Professional Measuring Tape 5 m
Oil Can 250 ccm
Padlock 40 mm
Adj. Hacksaw Frame
Universal Plier 240 mm

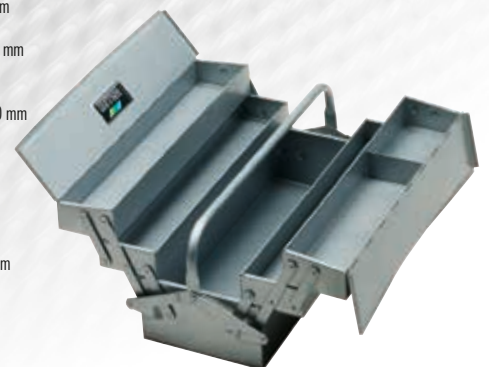

1731

Schutzbrille mit Sehglasaufnahme „Sport“ Protective Glasses with Eyeglass-Holder „Sport“

**Neu
New**

Seite Page
63

Bestell-No.
Order-No.

01731000000

CE EN 166
ANSI Z87.1



- Zertifizierte Produktion
- Sportliches Modell
- Integrierter, herausnehmbarer Brillenrahmen zur Aufnahme Ihrer individuellen Sehgläser
- Angenehmer Tragekomfort durch 2-K Weichkomponente an den Bügeln
- Auch ohne Sehglasaufnahme als Schutzbrille nutzbar

- Certified production
- Sportive model
- Integrated, removeable spectacle frame as holder for your individual glasses
- 2-K soft component on the temple arms for high wearing comfort
- Can be used as protective glasses without eyeglass-holder



1731-1

Schutzbrille mit Sehglasaufnahme „Konventionell“ Protective Glasses with Eyeglass-Holder „Conventional“

**Neu
New**

Seite Page
63

Bestell-No.
Order-No.

01731000100

CE EN 166
ANSI Z87.1



- Zertifizierte Produktion
- Konventionelles Modell
- Integrierter, herausnehmbarer Brillenrahmen zur Aufnahme Ihrer individuellen Sehgläser
- Angenehmer Tragekomfort durch 2-K Weichkomponente an den Bügeln
- Auch ohne Sehglasaufnahme als Schutzbrille nutzbar

- Certified production
- Conventional model
- Integrated, removeable spectacle frame as holder for your individual glasses
- 2-K soft component on the temple arms for high wearing comfort
- Can be used as protective glasses without eyeglass-holder





16 20



20 31

1/4 3/8 1/2 3/4 1



31 46



47 51



52 57

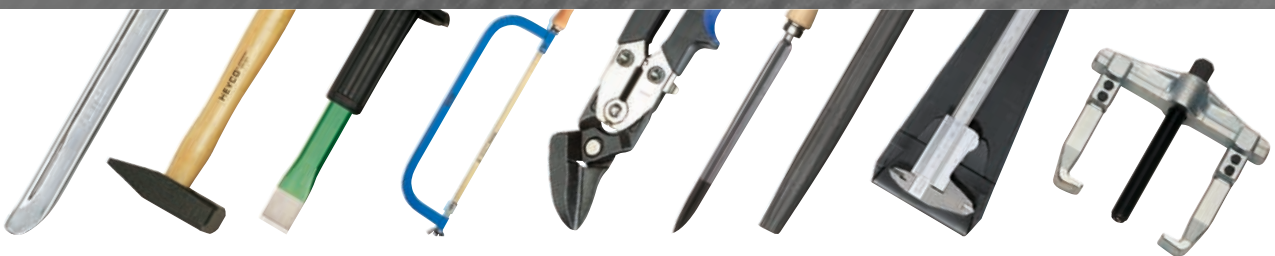

58 68

Bestell-Nr. Order-No.	EAN 402 40 89 +	Code-Nr.	Artikel No. / Seite	Notizen / Notes	69 76
07972180080 502422682 02422682 02282 000	161014 162684 162877 158939 166446 166408 166453 166460 165562 165586 65579 324 55	EAN-Nr.	Article / page		
		Seite	HEYCO No.		
		18	410		
		18	K 410		
		18	430		
		19	450		
		9	K 450		
			475		
			K 475		
			R 475		
			491		
			23		
			23		

350 DIN 3110 / ISO 1085



Bestell-No. Order-No.	ØMM	
00350040582	4 x 5	10
00350055582	5 x 5,5	10
00350055782	5,5 x 7	10
00350060782	6 x 7	10
00350080982	8 x 9	10
00350081082	8 x 10	10
00350101182	10 x 11	10
00350101282	10 x 12	10
00350101382	10 x 13	10
00350111382	11 x 13	10
00350121382	12 x 13	10
00350121482	12 x 14	10
00350131482	13 x 14	10
00350131582	13 x 15	10
00350131682	13 x 16	10
00350131782	13 x 17	10
00350141582	14 x 15	10
00350141782	14 x 17	10
00350161782	16 x 17	10
00350161882	16 x 18	10
00350171982	17 x 19	10
00350181982	18 x 19	10
00350182182	18 x 21	10
00350192282	19 x 22	10
00350192482	19 x 24	10
00350202282	20 x 22	10
00350212382	21 x 23	5
00350212482	21 x 24	5
00350222482	22 x 24	5
00350242682	24 x 26	5
00350242782	24 x 27	5
00350252882	25 x 28	5
00350272982	27 x 29	5
00350273082	27 x 30	5
00350273282	27 x 32	5
00350303282	30 x 32	5
00350303482	30 x 34	5
00350303682	30 x 36	5
00350323682	32 x 36	5
00350364182	36 x 41	5
00350414682	41 x 46	5
00350465082	46 x 50	3

Bestell-No. Order-No.	ØAF	
00350660682	1/4 x 5/16	10
00350660982	5/16 x 3/8	10
00350661382	3/8 x 7/16	10
00350661782	7/16 x 1/2	10
00350661982	1/2 x 9/16	10
00350662282	9/16 x 5/8	10
00350662582	19/32 x 11/16	10
00350662782	5/8 x 11/16	10
00350662882	5/8 x 3/4	10
00350663082	11/16 x 3/4	10
00350663582	3/4 x 25/32	10
00350663782	3/4 x 7/8	10
00350664182	13/16 x 7/8	10
00350664382	7/8 x 15/16	5
00350664682	15/16 x 1	5
00350665082	1 x 1.1/8	5
00350665382	1.1/16 x 1.1/4	5
00350665582	1.1/8 x 1.5/16	5
00350665882	1.3/16 x 1.5/16	5
00350666082	1.1/4 x 1.3/8	5
00350666482	1.5/16 x 1.1/2	5
00350666882	1.7/16 x 1.5/8	5
00350666982	1.1/2 x 1.5/8	5
00350667482	1.11/16 x 1.7/8	5
00350667782	1.13/16 x 2	3

B 350



Bestell-No. Order-No.	No.	ØMM	tlg./pcs.	
00350844082	B 350-8-M	6 - 22	8	1

HP 350



im Kunststoffhalter/
in plastic holder

Bestell-No. Order-No.	No.	ØMM	tlg./pcs.	△	
00350644082	HP 350-8-M	6 - 22	8	812	1
		6 x 7 8 x 9 10 x 11			
		12 x 13 14 x 15 16 x 17			
		18 x 19 20 x 22			

K 350

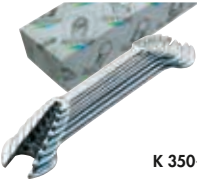

K 350-8

Bestell-No. Order-No.	No.	ØMM	tlg./pcs.	
00350942082	K 350-6-M-1	6 - 17	6	1
00350942182	K 350-6-M-2	8 - 19	6	1
00350942282	K 350-6-M-3	10 - 22	6	1
00350943482	K 350-7-M	6 - 22	7	1
00350943582	K 350-7-M-1	5,5 - 34	7	1
00350944082	K 350-8-M	6 - 22	8	1
00350945582	K 350-10-M	6 - 27	10	1
00350945682	K 350-10-M-1	6 - 26	10	1
00350947082	K 350-12-M	6 - 32	12	1
00350947282	K 350-12-M-2	6 - 32	12	1
00350948082	K 350-13-M	6 - 32	13	1
00350948582	K 350-14-M	6 - 50	14	1
00350948682	K 350-14-M-1	6 - 50	14	1

Bestell-No. Order-No.	No.	ØAF	tlg./pcs.	
00350962082	K 350-6-AF-1	1/4 - 7/8	6	1
00350962182	K 350-6-AF-2	3/8 - 1	6	1
00350964082	K 350-8-AF	1/4 - 1.1/4	8	1
00350967082	K 350-12-AF	1/4 - 1.1/4	12	1

R 350



R 350-8

Bestell-No. Order-No.	No.	ØMM	tlg./pcs.	
00350744082	R 350-8-M	6 - 22	8	1
00350747082	R 350-12-M	6 - 32	12	1
00350747182	R 350-12-M-1	6 - 32	12	1

Bestell-No. Order-No.	No.	ØAF	tlg./pcs.	
00350767082	R 350-12-AF	1/4 - 1.1/4	12	1

894 DIN 894 / ISO 3318



Bestell-No. Order-No.	ØMM	
00894006036	6	10
00894007036	7	10
00894008036	8	10
00894009036	9	10
00894010036	10	10
00894011036	11	10
00894012036	12	10
00894013036	13	10
00894014036	14	10
00894015036	15	10

Bestell-No. Order-No.	ØMM	
00894017036	17	10
00894018036	18	10
00894019036	19	10
00894022036	22	10
00894024036	24	10
00894027036	27	5
00894030036	30	5
00894032036	32	5
00894036036	36	5
00894038036	38	5
00894041036	41	5
00894046036	46	5
00894050036	50	5
00894055036	55	3
00894060036	60	1
00894065036	65	1
00894070036	70	1
00894075036	75	1

Bestell-No. Order-No.	ØMM	
00894080020	80	1
00894085020	85	1
00894090020	90	1
00894095020	95	1
00894100020	100	1
00894105020	105	1
00894110020	110	1
00894115020	115	1
00894120020	120	1
00894125020	125	1
00894130020	130	1
00894135020	135	1

895 DIN 894 / ISO 3318



Bestell-No. Order-No.	ØMM	
00895060736	6 x 7	10
00895080936	8 x 9	10
00895081036	8 x 10	10
00895091036	9 x 10	10
00895091136	9 x 11	10
00895101136	10 x 11	10
00895101236	10 x 12	10
00895101336	10 x 13	10
00895101436	10 x 14	10
00895111336	11 x 13	10
00895121336	12 x 13	10
00895121436	12 x 14	10
00895131436	13 x 14	10
00895131536	13 x 15	10
00895131736	13 x 17	10
00895141536	14 x 15	10
00895141736	14 x 17	10
00895161736	16 x 17	10
00895161836	16 x 18	10
00895171936	17 x 19	10
00895172136	17 x 21	10
00895172236	17 x 22	10
00895192236	19 x 22	10
00895192436	19 x 24	10
00895212336	21 x 23	5
00895222436	22 x 24	5
00895222736	22 x 27	5
00895242736	24 x 27	5
00895242936	24 x 29	5
00895243036	24 x 30	5
00895273236	27 x 32	5
00895303236	30 x 32	5
00895303636	30 x 36	5
00895323636	32 x 36	5
00895364136	36 x 41	5
00895414636	41 x 46	5
00895465036	46 x 50	3
00895505536	50 x 55	1
00895566036	55 x 60	1

Bestell-No. Order-No.	ØMM	
00895657020	65 x 70	1
00895758020	75 x 80	1

K 895



13

K 895-8

Bestell-No. Order-No.	No.	MM	tlg./pcs.	
00895942036	K 895-6-M-1	6 - 17	6	1
00895942136	K 895-6-M-2	8 - 19	6	1
00895942236	K 895-6-M-3	10 - 22	6	1
00895944036	K 895-8-M	6 - 22	8	1
00895947036	K 895-12-M	6 - 32	12	1

370



13

Bestell-No. Order-No.	No.	MM	tlg./pcs.	
00370524050	370-M	4 - 7,5	11	10

Bestell-No. Order-No.	No.	MM	tlg./pcs.	
00370534050	370-AF	3/16 - 7/16	11	10

380



14

Bestell-No. Order-No.	MM	
00380001380	13	5
00380001480	14	5
00380001780	17	5
00380001980	19	5
00380002280	22	5
00380002480	24	5
00380002780	27	5
00380003080	30	5
00380003280	32	5
00380003680	36	3
00380004180	41	3
00380004680	46	1
00380005080	50	1
00380005580	55	1
00380006080	60	1

390 DIN 3117 A / 3117 B

14



PHS



CP

Bestell-No. Order-No.	L		max.		
	mm	"	mm	"	
00390000437	115	4	13	1/2	1
00390000637	160	6	20	11/16	1
00390000837	205	8	24	7/8	1
00390001037	255	10	29	1.1/8	1
00390001237	310	12	34	1.5/16	1
00390001537	380	15	44	1.11/16	1
00390001837	460	18	53	2.1/16	1

Bestell-No. Order-No.	L		max.		
	mm	"	mm	"	
00390000482	115	4	13	1/2	1
00390000682	160	6	20	11/16	1
00390000882	205	8	24	7/8	1
00390001082	255	10	29	1.1/8	1
00390001282	310	12	34	1.5/16	1
00390001582	380	15	44	1.11/16	1
00390001882	460	18	53	2.1/16	1

392



14

Übergroße Maulweite/
super wide opening

Bestell-No. Order-No.	L		max.		
	mm	"	mm	"	
00392340682	150	6	34	1.3/8	1
00392390882	200	8	39	1.1/2	1

400 DIN 3113 A

15



5,5 - 50 mm - AF 1/4 - 2 - W 1/8 - 7/16

DIN 3113 B



55 - 80 mm - AF 2.1/8 - 2.7/16

Bestell-No. Order-No.	MM	
00400005582	5,5	10
00400006082	6	10
00400007082	7	10
00400008082	8	10
00400009082	9	10
00400010082	10	10
00400011082	11	10
00400012082	12	10
00400013082	13	10
00400014082	14	10
00400015082	15	10
00400016082	16	10
00400017082	17	10
00400018082	18	10
00400019082	19	10
00400020082	20	10
00400021082	21	10
00400022082	22	10
00400023082	23	10
00400024082	24	5
00400025082	25	5
00400026082	26	5
00400027082	27	5
00400028082	28	5
00400029082	29	5
00400030082	30	5
00400032082	32	5
00400034082	34	5
00400036082	36	5
00400038082	38	5
00400041082	41	3
00400046082	46	1
00400050082	50	1

Bestell-No. Order-No.	MM	
00400055080	55	1
00400060080	60	1
00400065080	65	1
00400070080	70	1
00400075080	75	1
00400080080	80	1

Bestell-No. Order-No.	AF	
00400631282	1/4	10
00400631682	5/16	10
00400631982	3/8	10
00400632182	7/16	10
00400632382	1/2	10
00400632582	9/16	10
00400632682	19/32	10
00400632782	5/8	10
00400632982	11/16	10
00400633182	3/4	10
00400633282	25/32	10
00400633382	13/16	10
00400633482	7/8	10
00400633582	15/16	5
00400633782	1	5
00400633882	1.1/16	5
00400633982	1.1/8	5
00400634182	1.1/4	5
00400634282	1.5/16	5
00400634382	1.3/8	5

Bestell-No. Order-No.	AF	
00400634482	1.7/16	5
00400634582	1.1/2	3
00400634782	1.5/8	3
00400634982	1.3/4	1
00400635082	1.13/16	1
00400635282	2	1

Bestell-No. Order-No.	AF	
00400635480	2.1/8	1
00400635580	2.3/16	1
00400635680	2.1/4	1
00400635780	2.5/16	1
00400635880	2.3/8	1
00400635980	2.7/16	1

B 400



16

B 400-12

Bestell-No. Order-No.	No.	MM	tlg./pcs.	
00400824082	B 400-8-M	6 - 19	8	1
00400827082	B 400-12-M	8 - 19	12	1

HP 400



16

im Kunststoffhalter/
in plastic holder

Bestell-No. Order-No.	No.	MM	tlg./pcs.			
00400627382	HP 400-12-M	6 - 19	12	1070	1	
		6	8	10	11	
		12	13	14	15	
		16	17	18	19	

K 400



16

K 400-8

Bestell-No. Order-No.	No.	MM	tlg./pcs.	
00400924082	K 400-8-M	6 - 19	8	1
00400924382	K 400-8-M-2	10 - 24	8	1
00400925582	K 400-10-M	8 - 22	10	1
00400927082	K 400-12-M	8 - 22	12	1
00400927282	K 400-12-M-2	6 - 22	12	1
00400927582	K 400-12-M-3	10 - 32	12	1
00400928582	K 400-14-M	8 - 24	14	1
00400928982	K 400-15-M	6 - 32	15	1
00400928882	K 400-16-M	6 - 32	16	1
00400929082	K 400-17-M	6 - 22	17	1
00400929582	K 400-22-M	8 - 32	22	1
00400929882	K 400-26-M	6 - 32	26	1

Bestell-No. Order-No.	No.	AF	tlg./pcs.	
00400932082	K 400-6-AF	3/8 - 3/4	6	1
00400934082	K 400-8-AF	5/16 - 3/4	8	1
00400935582	K 400-10-AF	5/16 - 7/8	10	1
00400937082	K 400-12-AF	5/16 - 1	12	1
00400939082	K 400-17-AF	1/4 - 1.1/4	17	1
00400939582	K 400-22-AF	1/4 - 1.1/2	22	1

R 400



R 400-8

Bestell-No. Order-No.	No.	MM	tlg./pcs.	
00400724082	R 400-8-M	6 - 19	8	1
00400727182	R 400-12-M-1	8 - 19	12	1
00400727282	R 400-12-M-2	6 - 22	12	1
00400728082	R 400-13-M	10 - 22	13	1
00400728182	R 400-13-M-2	6 - 22	13	1

Bestell-No. Order-No.	No.	AF	tlg./pcs.	
00400734082	R 400-8-AF	5/16 - 3/4	8	1
00400737082	R 400-12-AF	5/16 - 1	12	1
00400738082	R 400-13-AF	1/4 - 1	13	1

410 ^{SP} DIN 3113 B / ISO 3318 + 7738



maxline

Bestell-No. Order-No.	MM	
00410010083	10	10
00410011083	11	10
00410012083	12	10
00410013083	13	10
00410014083	14	10
00410015083	15	10
00410016083	16	10
00410017083	17	10
00410018083	18	10
00410019083	19	10
00410020083	20	10
00410021083	21	5
00410022083	22	5
00410024083	24	5
00410027083	27	5
00410030083	30	5
00410032083	32	5
00410034083	34	3
00410036083	36	3
00410041083	41	3

K 410

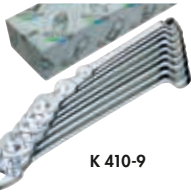

K 410-9

maxline

Bestell-No. Order-No.	No.	MM	tlg./pcs.	
00410945083	K 410-9-M	10 - 24	9	1
00410946083	K 410-11-M	10 - 30	11	1
00410948583	K 410-14-M	10 - 24	14	1

430



Bestell-No. Order-No.	MM	
00430111382	11 x 13	5
00430141682	14 x 16	5
00430141782	14 x 17	5
00430192282	19 x 22	5

450



Bestell-No. Order-No.	MM	
00450060782	6 x 7	10
00450080982	8 x 9	10
00450101182	10 x 11	10
00450101382	10 x 13	10
00450121382	12 x 13	10
00450131782	13 x 17	10
00450141582	14 x 15	10
00450141782	14 x 17	10
00450161782	16 x 17	10
00450171982	17 x 19	10
00450181982	18 x 19	10
00450202282	20 x 22	10
00450212382	21 x 23	5
00450222482	22 x 24	5
00450242682	24 x 26	5
00450242782	24 x 27	5
00450252882	25 x 28	5
00450303282	30 x 32	5
00450364182	36 x 41	5

K 450



K 450-8

Bestell-No. Order-No.	No.	MM	tlg./pcs.	
00450944082	K 450-8-M	6 - 22	8	1
00450947082	K 450-12-M	6 - 32	12	1

475 ^{SP} DIN 838 / ISO 1085



Bestell-No. Order-No.	MM	
00475055782	5,5 x 7	10
00475060782	6 x 7	10
00475070882	7 x 8	10
00475080982	8 x 9	10
00475081082	8 x 10	10
00475091182	9 x 11	10
00475101182	10 x 11	10
00475101382	10 x 13	10
00475111382	11 x 13	10
00475121382	12 x 13	10
00475121482	12 x 14	10
00475131482	13 x 14	10
00475131582	13 x 15	10
00475131682	13 x 16	10
00475131782	13 x 17	5
00475141582	14 x 15	10
00475141782	14 x 17	5
00475161782	16 x 17	5
00475161882	16 x 18	5
00475171982	17 x 19	5
00475181982	18 x 19	5
00475182182	18 x 21	5
00475192282	19 x 22	5
00475192482	19 x 24	5
00475202282	20 x 22	5
00475212382	21 x 23	5
00475212482	21 x 24	5
00475222482	22 x 24	5
00475242682	24 x 26	5
00475242782	24 x 27	5
00475243082	24 x 30	5
00475252882	25 x 28	5

Bestell-No. Order-No.	MM	
00475272982	27 x 29	5
00475273082	27 x 30	5
00475273282	27 x 32	5
00475303282	30 x 32	5
00475303482	30 x 34	5
00475303682	30 x 36	5
00475323682	32 x 36	5
00475364182	36 x 41	3
00475414682	41 x 46	3
00475465082	46 x 50	1
00475556080	55 x 60	1
00475657080	65 x 70	1
00475758080	75 x 80	1

Bestell-No. Order-No.	AF	
00475660682	1/4 x 5/16	10
00475660982	5/16 x 3/8	10
00475661382	3/8 x 7/16	10
00475661782	7/16 x 1/2	10
00475661982	1/2 x 9/16	10
00475662282	9/16 x 5/8	10
00475662782	5/8 x 11/16	5
00475662882	5/8 x 3/4	5
00475663082	11/16 x 3/4	5
00475663582	3/4 x 25/32	5
00475663782	3/4 x 7/8	5
00475664182	13/16 x 7/8	5
00475664382	7/8 x 15/16	5
00475664682	15/16 x 1	5
00475665082	1 x 1.1/8	5
00475665382	1.1/16 x 1.1/4	5
00475665582	1.1/8 x 1.5/16	5
00475665882	1.3/16 x 1.5/16	5
00475666082	1.1/4 x 1.3/8	5
00475666482	1.5/16 x 1.1/2	5
00475666882	1.7/16 x 1.5/8	3
00475667482	1.11/16 x 1.7/8	3
00475667782	1.13/16 x 2	1

K 475



K 475-8

Bestell-No. Order-No.	No.	MM	tlg./pcs.	
00475942082	K 475-6-M-1	6 - 17	6	1
00475942182	K 475-6-M-2	8 - 19	6	1
00475944082	K 475-8-M	6 - 22	8	1
00475947082	K 475-12-M	6 - 32	12	1
00475948582	K 475-14-M	6 - 50	14	1

Bestell-No. Order-No.	No.	AF	tlg./pcs.	
00475962082	K 475-6-AF-1	1/4 - 7/8	6	1
00475962182	K 475-6-AF-2	3/8 - 1	6	1
00475964082	K 475-8-AF	1/4 - 1.1/4	8	1
00475967082	K 475-12-AF	1/4 - 1.1/4	12	1

R 475



R 475-8

Bestell-No. Order-No.	No.	MM	tlg./pcs.	
00475744082	R 475-8-M	6 - 22	8	1
00475747082	R 475-12-M	6 - 32	12	1
00475747182	R 475-12-M-1	6 - 32	12	1

Bestell-No. Order-No.	No.	AF	tlg./pcs.	
00475767082	R 475-12-AF	1/4 - 1.1/4	12	1

493



6 x 7 mm

8 x 9 - 21 x 23 mm
AF 3/8 x 7/16 - 3/4 x 7/8

Bestell-No. Order-No.	MM	
00493060782	6 x 7	10
00493080982	8 x 9	10
00493101182	10 x 11	10
00493121382	12 x 13	10
00493141582	14 x 15	10
00493161782	16 x 17	10
00493181982	18 x 19	5
00493202282	20 x 22	5

Bestell-No. Order-No.	AF	
00493661382	3/8 x 7/16	10
00493661982	1/2 x 9/16	10
00493662782	5/8 x 11/16	10
00493663782	3/4 x 7/8	5

R 493



R 493-8

Bestell-No. Order-No.	No.	MM	tlg./pcs.	
00493742082	R 493-6-M-1	6 - 17	6	1
00493742182	R 493-6-M-2	8 - 19	6	1
00493743082	R 493-7-M	8 - 22	7	1

495



■ für Innenvierkantschrauben/
for hollow square screws

■ für Ölfaß-Schlitzschrauben/
for slotted oil barrel plug

Bestell-No. Order-No.	■	■	
00495000080	9	1	5

497 SP DIN 3118



MM 8 x 10 - 13 x 14 (SP) MM 14 x 17 - 30 x 32

Bestell-No. Order-No.	MM	
00497081080	8 x 10	10
00497091180	9 x 11	10
00497101180	10 x 11	10
00497101280	10 x 12	10
00497111380	11 x 13	10
00497121480	12 x 14	10
00497131480	13 x 14	10
00497131580	13 x 15	10
00497141780	14 x 17	5
00497171980	17 x 19	5
00497192280	19 x 22	5
00497222480	22 x 24	5
00497242680	24 x 26	5
00497242780	24 x 27	5
00497303280	30 x 32	5

800 DIN 1810 A



Bestell-No. Order-No.	mm	
00800001230	12/14	10
00800001630	16/20	10
00800002530	25/28	10
00800003030	30/32	10
00800003430	34/36	10
00800004030	40/42	10
00800004530	45/50	10
00800005230	52/55	10
00800005830	58/62	10
00800006830	68/75	10
00800008030	80/90	5
00800009530	95/100	5
00800011030	110/115	5
00800012030	120/130	5
00800013530	135/145	5
00800015530	155/165	5
00800018030	180/195	5
00800020530	205/220	5
00800023030	230/245	1

808 DIN 3111 / ISO 3318



Bestell-No. Order-No.	MM	
00808001320	13	10
00808001420	14	10
00808001720	17	10
00808001920	19	10
00808002220	22	10
00808002420	24	10
00808002720	27	10
00808003020	30	10
00808003220	32	10
00808003620	36	5
00808004120	41	5
00808004620	46	3
00808005020	50	3
00808005520	55	3
00808006020	60	1
00808006520	65	1

810 DIN 133



Bestell-No. Order-No.	MM	
00810002420	24	5
00810002720	27	5
00810003020	30	5
00810003220	32	5
00810003620	36	5
00810003820	38	5
00810004120	41	5
00810004620	46	3
00810005020	50	3
00810005520	55	3
00810006020	60	1
00810006520	65	1
00810007020	70	1
00810007520	75	1
00810008020	80	1
00810008520	85	1
00810009020	90	1

Bestell-No. Order-No.	MM	
00810009520	95	1
00810010020	100	1
00810010520	105	1
00810011020	110	1
00810011520	115	1
00810012020	120	1
00810012520	125	1
00810013020	130	1
00810013520	135	1
00810014020	140	1
00810014520	145	1
00810015020	150	1
00810015520	155	1
00810016020	160	1
00810016520	165	1
00810017020	170	1
00810017520	175	1
00810018020	180	1
00810018520	185	1
00810019020	190	1
00810019520	195	1
00810020020	200	1
00810021020	210	1
00810022020	220	1
00810023020	230	1

Bestell-No. Order-No.	AF	
00810633420	7/8	5
00810633720	1	5
00810633820	1.1/16	5
00810633920	1.1/8	5
00810634020	1.3/16	5
00810634120	1.1/4	5
00810634220	1.5/16	5
00810634320	1.3/8	5
00810634420	1.7/16	5
00810634520	1.1/2	5
00810634620	1.9/16	5
00810634720	1.5/8	5
00810634820	1.11/16	5
00810634920	1.3/4	5
00810635020	1.13/16	3
00810635120	1.7/8	3
00810638020	1.15/16	3
00810635220	2	3
00810635320	2.1/16	3
00810635420	2.1/8	3
00810635520	2.3/16	3
00810635620	2.1/4	3
00810635720	2.5/16	3
00810635820	2.3/8	1
00810635920	2.7/16	1
00810636020	2.1/2	1
00810636120	2.9/16	1
00810636220	2.5/8	1
00810639520	2.11/16	1
00810636320	2.3/4	1
00810636420	2.13/16	1
00810638320	2.7/8	1
00810636520	2.15/16	1
00810636620	3	1
00810636720	3.1/8	1
00810636820	3.1/4	1
00810636920	3.3/8	1
00810637020	3.1/2	1
00810637120	3.5/8	1
00810637220	3.3/4	1
00810637320	3.7/8	1
00810637420	4	1
00810637520	4.1/8	1
00810637620	4.1/4	1
00810639620	4.3/8	1
00810637720	4.1/2	1
00810637820	4.5/8	1
00810638120	4.3/4	1
00810639720	4.7/8	1
00810638220	5	1
00810637920	5.1/4	1
00810638620	5.1/2	1
00810638720	5.5/8	1
00810639020	6	1



Bestell-No. Order-No.	MM	
00820002420	24	5
00820002720	27	5
00820003020	30	5
00820003220	32	5
00820003620	36	5
00820003820	38	5
00820004120	41	5
00820004620	46	3
00820005020	50	3
00820005520	55	3
00820006020	60	1
00820006520	65	1
00820007020	70	1
00820007520	75	1
00820008020	80	1
00820008520	85	1
00820009020	90	1
00820009520	95	1
00820010020	100	1
00820010520	105	1
00820011020	110	1
00820011520	115	1
00820012020	120	1
00820012520	125	1
00820013020	130	1
00820013520	135	1
00820014020	140	1
00820014520	145	1
00820015020	150	1
00820015520	155	1
00820016020	160	1
00820016520	165	1
00820017020	170	1
00820017520	175	1
00820018020	180	1
00820018520	185	1
00820019020	190	1
00820019520	195	1
00820020020	200	1
00820021020	210	1
00820022020	220	1
00820023020	230	1

Bestell-No. Order-No.	AF	
00820633420	7/8	5
00820633720	1	5
00820633820	1.1/16	5
00820633920	1.1/8	5
00820634020	1.3/16	5
00820634120	1.1/4	5
00820634220	1.5/16	5
00820634320	1.3/8	5
00820634420	1.7/16	5
00820634520	1.1/2	5
00820634620	1.9/16	5
00820634720	1.5/8	5
00820634820	1.11/16	5
00820634920	1.3/4	3
00820635020	1.13/16	3
00820635120	1.7/8	3

Bestell-No. Order-No.	AF	
00820638020	1.15/16	3
00820635220	2	3
00820635320	2.1/16	3
00820635420	2.1/8	3
00820635520	2.3/16	3
00820635620	2.1/4	3
00820635720	2.5/16	1
00820635820	2.3/8	1
00820635920	2.7/16	1
00820636020	2.1/2	1
00820636120	2.9/16	1
00820636220	2.5/8	1
00820639520	2.11/16	1
00820636320	2.3/4	1
00820636420	2.13/16	1
00820638320	2.7/8	1
00820636520	2.15/16	1

Bestell-No. Order-No.	AF	
00820636620	3	1
00820636720	3.1/8	1
00820636820	3.1/4	1
00820636920	3.3/8	1
00820637020	3.1/2	1
00820637120	3.5/8	1
00820637220	3.3/4	1
00820637320	3.7/8	1
00820637420	4	1
00820637520	4.1/8	1
00820637620	4.1/4	1
00820639620	4.3/8	1
00820637720	4.1/2	1
00820637820	4.5/8	1
00820638120	4.3/4	1
00820639720	4.7/8	1
00820638220	5	1
00820638420	5.1/8	1
00820637920	5.1/4	1
00820638520	5.3/8	1
00820638620	5.1/2	1
00820638720	5.5/8	1
00820638820	5.3/4	1
00820638920	5.7/8	1
00820639020	6	1

840



Andere Größen auf Anfrage/
other sizes on request

Bestell-No. Order-No.	MM	passendes Rohr / to be used with handle	
00840002280	22		5
00840002480	24	845-0	5
00840002780	27		5
00840003080	30		5
00840003280	32		5
00840003680	36	845-1	5
00840004180	41		5
00840004680	46		3
00840005080	50	845-2	3
00840005580	55		3
00840006080	60		1
00840006580	65		1
00840007080	70		1
00840007580	75		1
00840008080	80	845-3	1
00840008580	85		1
00840009080	90		1
00840009580	95		1
00840010080	100		1

845



Bestell-No. Order-No.	No.	für / for HEYCO 840	
00845000060	845-0	22-30 mm	5
00845000160	845-1	32-41 mm	1
00845000260	845-2	46-55 mm	1
00845000360	845-3	60-100 mm	1

25-00-10 **VARICAT**
Verkaufsständer / Display Stands
No. 1186

25-01-1

25-03

25-04

25-05

25-05-1

25-05-5

25-06

25-07

25-08

25-11

25-15 1/4 3/8

25-16

6101-30 Verbindungsstück für Bits 1/4" /
connector for bits 1/4"

Bestell-No. Order-No.	No.	mm	
00025010083	25-00-10	140	1
00025011080	25-01-1	150	10
00025030083	25-03	114	10
00025040083	25-04	55	10
00025050083	25-05	105	10
00025051083	25-05-1	150	10
00025055083	25-05-5	100	10
00025060083	25-06	35	10
00025070083	25-07	155	10
00025080083	25-08	145	10
00025110080	25-11	120	10
00025150083	25-15	27	10
00025160083	25-16	20	10
06101003080	6101-30	20	10



Bestell-No. Order-No.	MM	
00025000483	4	10
000250004583	4,5	10
00025000583	5	10
00025005583	5,5	10
00025000683	6	10
00025000783	7	10
00025000883	8	10
00025000983	9	10
00025001083	10	10
00025001183	11	10
00025001283	12	10
00025001383	13	10
00025001483	14	10

Bestell-No. Order-No.	AF	
00025630583	1/8	10
00025630783	5/32	10
00025630883	3/16	10
00025631083	7/32	10
00025631283	1/4	10
00025631483	9/32	10
00025631683	5/16	10
00025631883	11/32	10
00025631983	3/8	10
00025632183	7/16	10
00025632383	1/2	10
00025632583	9/16	10

25-19 $\frac{1}{4}$ SP

DIN 3124 / ISO 2725



Bestell-No. Order-No.	MM	
00025190483	4	10
00025194583	4,5	10
00025190583	5	10
00025195583	5,5	10
00025190683	6	10
00025190783	7	10
00025190883	8	10
00025190983	9	10
00025191083	10	10
00025191183	11	10
00025191283	12	10
00025191383	13	10
00025191483	14	10

25-20 $\frac{1}{4}$ SP



Bestell-No. Order-No.	Größe/size	mm	
00025200483	E 4	3,86	10
00025200583	E 5	4,75	10
00025200683	E 6	5,74	10
00025200783	E 7	6,22	10
00025200883	E 8	7,52	10
00025201083	E 10	9,42	10

25-30 - 25-36 $\frac{1}{4}$ SP



Bestell-No. Order-No.	mm	mm	mm	
00025300183	3	0,5	34,5	10
00025300283	3,5	0,6	34,5	10
00025300383	4	0,8	34,5	10
00025300483	5,5	1,0	34,5	10
00025300583	6,5	1,2	34,5	10
00025300683	8	1,2	34,5	10

25-31

Bestell-No. Order-No.	MM	mm	
00025310183	3	34,5	10
00025310283	4	34,5	10
00025310383	5	34,5	10
00025310483	6	34,5	10
00025310583	8	34,5	10

Bestell-No. Order-No.	AF	mm	
00025313083	1/8	34,5	10
00025313183	5/32	34,5	10
00025313283	3/16	34,5	10
00025313383	7/32	34,5	10
00025313483	1/4	34,5	10
00025313683	5/16	34,5	10

25-32

Bestell-No. Order-No.	No.	mm	
00025320183	1	34,5	10
00025320283	2	34,5	10
00025320383	3	34,5	10
00025320483	4	34,5	10

25-35

Bestell-No. Order-No.	No.	mm	
00025350183	1	34,5	10
00025350283	2	34,5	10
00025350383	3	34,5	10
00025350483	4	34,5	10

25-36

Bestell-No. Order-No.	Größe/size	mm	mm	
00025360683	T 6	1,67	34,5	10
00025360783	T 7	1,99	34,5	10
00025360883	T 8	2,31	34,5	10
00025360983	T 9	2,50	34,5	10
00025361083	T 10	2,74	34,5	10
00025361583	T 15	3,27	34,5	10
00025362083	T 20	3,86	34,5	10
00025362583	T 25	4,43	34,5	10
00025362783	T 27	4,99	34,5	10
00025363083	T 30	5,52	34,5	10
00025364083	T 40	6,65	34,5	10

25-50 $\frac{1}{4}$ SP



Bestell-No. Order-No.	No.	tlg./pcs.	
00025500083	25-50-E/T	17	1

25-70 $\frac{1}{4}$ SP



Bestell-No. Order-No.	No.	MM	tlg./pcs.	
98710251600	leer/empty		1	253
00025700083	25-70-M	4 - 14	13	465
		4 4,5 5 5,5 6 7 8		
		9 10 11 12 13 14		

27-80 - 27-4010 $\frac{1}{4}$ SP



Bestell-No. Order-No.	No.	tlg./pcs.	
00027301083	27-3010-M	17	1
00027800083	27-80-M	17	1
00027401083	27-4010-AF	17	1
00027900083	27-90-AF	17	1

27-3510 $\frac{1}{4}$ SP



Bestell-No. Order-No.	No.	tlg./pcs.	
00027351083	27-3510-M	18	1

29-3010 $\frac{1}{4}$ SP



Bestell-No. Order-No.	No.	tlg./pcs.	
00029301083	29-3010-M	29	1

30-3010 $\frac{1}{4}$ SP



Bestell-No. Order-No.	No.	tlg./pcs.	
00030301083	30-3010-M	49	1

31-1910 $\frac{1}{4}$ SP



Bestell-No. Order-No.	No.	tlg./pcs.	
00031191083	31-1910-M	28	1

40-00-1 - 40-16

DIN 3122 + 3123

3/8 3/8



HEYCO
VARICAT

Verkaufständer / Display Stands
No. 1186



Bestell-No. Order-No.	No.	←L→ mm	
00040011082	40-00-1	198	5
00040007082	40-00-7	198	5
00040011083	40-00-10	200	1
00040027082	40-00-27	50	5
00040020083	40-02	304	5
00040030083	40-03	200	10
00040040083	40-04	125	10
00040041083	40-04-1	75	10
00040041583	40-04-15	75	10
00040042583	40-04-25	150	10
00040050083	40-05	250	10
00040055083	40-05-5	250	10
00040060083	40-06	50	10
00040070083	40-07	224	10
00040140083	40-14	25	10
00040150083	40-15	35	10
00040160083	40-16	25	10
06201003080	6201-30	20	10

40-6

DIN 3124
ISO 2725

3/8 SP



Bestell-No. Order-No.	ØMM	
00040600683	6	10
00040600783	7	10
00040600883	8	10
00040600983	9	10
00040601083	10	10
00040601183	11	10

Bestell-No. Order-No.	ØMM	
00040601283	12	10
00040601383	13	10
00040601483	14	10
00040601583	15	10
00040601683	16	10
00040601783	17	10
00040601883	18	10
00040601983	19	10
00040602083	20	10
00040602183	21	10
00040602283	22	10

40-12

DIN 3124
ISO 2725

3/8 SP



Bestell-No. Order-No.	ØMM	
00040000683	6	10
00040000783	7	10
00040000883	8	10
00040000983	9	10
00040001083	10	10
00040001183	11	10
00040001283	12	10
00040001383	13	10
00040001483	14	10
00040001583	15	10
00040001683	16	10
00040001783	17	10
00040001883	18	10
00040001983	19	10
00040002083	20	10
00040002183	21	10
00040002283	22	10

Bestell-No. Order-No.	ØAF	
00040031283	1/4	10
00040031483	9/32	10
00040031683	5/16	10
00040031883	11/32	10
00040031983	3/8	10
00040032183	7/16	10
00040032383	1/2	10
00040032583	9/16	10

Bestell-No. Order-No.	ØAF	
00040032683	19/32	10
00040032783	5/8	10
00040032883	21/32	10
00040032983	11/16	10
00040033183	3/4	10
00040033283	25/32	10
00040033383	13/16	10
00040033483	7/8	10

40-17-1/2

Glühkerzeneinsätze
mit Gelenk / Glow Plug Sockets
with Joint

Neu
New

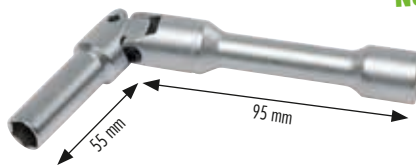

- Chrom-Vanadium, verchromt
- Mit geschraubtem Kardangelen
- Ideal für enge Bauräume
- Mit Gummieinsatz zum Halten der losen Glühkerze
- Länge: 160 mm
- Chrome-Vanadium, chromium plated
- With bolted universal joint
- Ideal for restricted locations
- With rubber insert to hold the loose glow plug
- Length: 160 mm

Bestell-No. Order-No.	No.	←L→ mm	ØMM	
00040170183	40-17-1	160	8	5
00040170283	40-17-2	160	10	5

40-18-1/2

Zündkerzenein-
sätze, extra lang / Spark Plug
Sockets, extra long

Neu
New



- Chrom-Vanadium, verchromt, teilweise poliert
- Besonders gut geeignet für extrem tiefsitzende Kerzen
- Kreuzrändelung für mehr Grip
- Chrome-Vanadium, chromium plated, head polished
- Best suited for extremely deep mounted spark/glow plug sockets
- Cross knurling provides better grip

Bestell-No. Order-No.	No.	←L→ mm	ØMM	
00040180183	40-18-1	250	14	5
00040180283	40-18-2	250	16	5

40-19-1 - 40-19-3



Bestell-No. Order-No.	No.	ØMM/AF	
00040190183	40-19-1	20,8 13/16	10
00040190283	40-19-2	18,0	10
00040190383	40-19-3	16,0 5/8	10

40-20

3/8



Bestell-No. Order-No.	Größe/size	mm	
00040200583	E 5	4,75	10
00040200683	E 6	5,74	10
00040200783	E 7	6,22	10
00040200883	E 8	7,52	10
00040201083	E 10	9,42	10
00040201283	E 12	11,17	10
00040201483	E 14	12,90	10

40-30 - 40-36



Bestell-No. Order-No.	mm	mm	←L→ mm	
00040300183	5,5	1,0	52,0	10
00040300283	8,0	1,2	52,0	10
00040300383	10,0	1,6	52,0	10

40-31

Bestell-No. Order-No.	ØMM	←L→ mm	
00040310183	4	42,0	10
00040310283	5	42,0	10
00040310383	6	42,0	10
00040310783	7	42,0	10
00040310483	8	42,0	10
00040310583	10	42,0	10

Bestell-No. Order-No.	ØAF	←L→ mm	
00040313083	1/8	42,0	10
00040313183	5/32	42,0	10
00040313283	3/16	42,0	10
00040313383	7/32	42,0	10
00040313483	1/4	42,0	10
00040313683	5/16	42,0	10
00040313883	3/8	42,0	10

40-32

Bestell-No. Order-No.	No.	← L → mm	
00040320183	1	46,0	10
00040320283	2	46,0	10
00040320383	3	46,0	10

40-35

Bestell-No. Order-No.	No.	← L → mm	
00040350183	1	46,0	10
00040350283	2	46,0	10
00040350383	3	46,0	10

40-36

Bestell-No. Order-No.	Größe/size	mm	← L → mm	
00040361083	T 10	2,74	45,0	10
00040361583	T 15	3,27	45,0	10
00040362083	T 20	3,86	45,0	10
00040362583	T 25	4,43	45,0	10
00040362783	T 27	4,99	45,0	10
00040363083	T 30	5,52	45,0	10
00040364083	T 40	6,65	45,0	10
00040364583	T 45	7,82	45,0	10
00040365083	T 50	8,83	48,0	10

40-50



Bestell-No. Order-No.	No.	tlg./pcs.	
00040500083	40-50-E/T	16	1

40-70 - 40-71

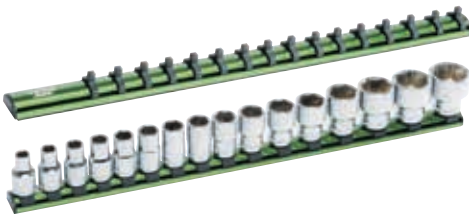

Bestell-No. Order-No.	No.	mm	tlg./pcs.			
98710401600	leer/empty		1	269	1	
00040700083	40-70-M	SP 6-22	16	891	1	
00040710083	40-71-M	SP 6-22	16	901	1	

40-75 - 40-88



Bestell-No. Order-No.	No.	tlg./pcs.	
00040750083	40-75-M	SP 347	1
00040760083	40-76-M	SP 347	1
00040850083	40-85-M	SP SP 314	1
00040880083	40-88-AF/M	SP 314	1

41-0010 - 41-3010



Bestell-No. Order-No.	No.	tlg./pcs.	
00041001083	41-0010-M	SP 24	1
00041500083	41-50-M	SP 24	1
00041301083	41-3010-M	SP 24	1
00041800083	41-80-M	SP 24	1
00041101083	41-1010-AF	SP 23	1

43-0010 - 43-3010



Bestell-No. Order-No.	No.	tlg./pcs.	
00043001083	43-0010-M	SP 15	1
00043500083	43-50-M	SP 15	1
00043301083	43-3010-M	SP 15	1
00043800083	43-80-M	SP 15	1
00043101083	43-1010-AF	SP 15	1

44-0010 - 44-3010



Bestell-No. Order-No.	No.	tlg./pcs.	
00044001083	44-0010-M	SP 23	1
00044500083	44-50-M	SP 23	1
00044301083	44-3010-M	SP 23	1
00044800083	44-80-M	SP 23	1

45-0010 - 45-3010



Bestell-No. Order-No.	No.	tlg./pcs.	
00045001083	45-0010-M	SP 39	1
00045500083	45-50-M	SP 39	1
00045301083	45-3010-M	SP 39	1
00045800083	45-80-M	SP 39	1

47-0010



Bestell-No. Order-No.	No.	tlg./pcs.	
00047001083	47-0010	20	1

50-00-1 - 50-16

DIN 3122 + 3123

50-00-1		
50-00-1		
50-00-7		
50-00-10		
<p>VERBODEN VARICAT Verkaufständer / Display Stands No. 1186</p>		
50-40-10		
<p>ta^oenta Verkaufständer / Display Stands No. 1187</p>		
50-00-18		
50-00-27		
50-02		
50-03		
50-04		
50-04-1		
50-04-5		
50-04-25		
50-05		
50-05-5		
50-06		
50-08		
50-09		
50-10		
50-14-1		
50-15		
50-16		

Bestell-No. Order-No.	No.	← L → mm	
00050011082	50-00-1	270	5
00050007082	50-00-7	270	5
00050010083	50-00-10	275	1
00050401083	50-40-10	200	1
00050018082	50-00-18	395	5
00050027082	50-00-27	55	5
00050020083	50-02	405	5
00050030083	50-03	300	10
00050040083	50-04	125	10
00050041083	50-04-1	75	10
00050042583	50-04-25	50	10
00050045083	50-04-5	125	10
00050050083	50-05	250	10
00050055083	50-05-5	250	10

Bestell-No. Order-No.	No.	← L → mm	
00050060083	50-06	70	10
00050080083	50-08	375	5
00050090083	50-09	450	5
00050100083	50-10	200	10
00050141083	50-14-1	36	10
00050150083	50-15	45	10
00050160083	50-16	34	10

50-6  
DIN 3124
ISO 2725





Bestell-No. Order-No.	MM	
00050600583	5	10
00050605583	5,5	10
00050600683	6	10
00050600783	7	10
00050600883	8	10
00050600983	9	10
00050601083	10	10
00050601183	11	10
00050601283	12	10
00050601383	13	10
00050601483	14	10
00050601583	15	10
00050601683	16	10
00050601783	17	10
00050601883	18	10
00050601983	19	10
00050602083	20	10
00050602183	21	10
00050602283	22	10
00050602383	23	10
00050602483	24	10
00050602583	25	10
00050602683	26	10
00050602783	27	10
00050602883	28	10
00050602983	29	10
00050603083	30	10
00050603283	32	10
00050603483	34	10



50-12  
DIN 3124
ISO 2725



Bestell-No. Order-No.	MM	
00050000883	8	10
00050000983	9	10
00050001083	10	10
00050001183	11	10
00050001283	12	10
00050001383	13	10
00050001483	14	10
00050001583	15	10
00050001683	16	10
00050001783	17	10
00050001883	18	10
00050001983	19	10
00050002083	20	10
00050002183	21	10
00050002283	22	10
00050002383	23	10
00050002483	24	10
00050002583	25	10
00050002683	26	10
00050002783	27	10
00050002883	28	10
00050002983	29	10
00050003083	30	10
00050003283	32	10
00050003383	33	10
00050003483	34	10

Bestell-No. Order-No.	AF	
00050031983	3/8	10
00050032183	7/16	10
00050032383	1/2	10
00050032583	9/16	10
00050032683	19/32	10
00050032783	5/8	10
00050032983	11/16	10
00050033183	3/4	10
00050033283	25/32	10
00050033383	13/16	10
00050033483	7/8	10
00050033583	15/16	10
00050033683	31/32	10
00050033783	1	10
00050033883	1.1/16	10
00050033983	1.1/8	10
00050034083	1.3/16	10
00050034183	1.1/4	10

Bestell-No. Order-No.	W	
00050070383	1/8	10
00050070483	3/16	10
00050070583	1/4	10
00050070683	5/16	10
00050070783	3/8	10
00050070883	7/16	10
00050070983	1/2	10
00050071083	9/16	10
00050071183	5/8	10
00050071283	11/16	10
00050071383	3/4	10

50-19  
DIN 3124
ISO 2725



Bestell-No. Order-No.	MM	
00050191082	10	10
00050191182	11	10
00050191282	12	10
00050191382	13	10
00050191482	14	10
00050191582	15	10
00050191682	16	10
00050191782	17	10
00050191882	18	10
00050191982	19	10
00050192182	21	10
00050192282	22	10
00050192482	24	10
00050192682	26	10
00050192782	27	10
00050193082	30	10
00050193282	32	10

Bestell-No. Order-No.	AF	
00050195282	9/16	10
00050195482	11/16	10
00050195582	3/4	10
00050195682	13/16	10
00050195782	15/16	10

50-19-1 **50-19-3**  



Bestell-No. Order-No.	No.	MM/AF	
00050190182	50-19-1	20,8 13/16	10
00050190382	50-19-3	16 5/8	10

50-20  





Bestell-No. Order-No.	Größe/size	mm	
00050201083	E 10	9,42	10
00050201183	E 11	10,08	10
00050201283	E 12	11,17	10
00050201483	E 14	12,90	10
00050201683	E 16	14,76	10
00050201883	E 18	16,70	10
00050202083	E 20	18,49	10
00050202483	E 24	22,16	10

50-30 - 50-36 





50-30 

Bestell-No. Order-No.	mm	mm	mm	
00050300183	8	1,2	62,0	10
00050300283	8	1,6	62,0	10
00050300383	10	1,6	62,0	10
00050300483	12	2,0	62,0	10
00050300583	14	2,5	62,0	10

50-31 

Bestell-No. Order-No.	MM	mm	
00050310183	4	52,0	10
00050310283	5	52,0	10
00050311483	5	180,0	10
00050310383	6	52,0	10
00050311583	6	137,0	10
00050311683	6	160,0	10
00050311783	7	52,0	10
00050311383	7	100,0	10
00050310483	8	52,0	10
00050311083	8	100,0	10
00050311283	8	120,0	10
00050310583	10	52,0	10
00050311183	10	140,0	10
00050310683	12	52,0	10
00050311883	12	140,0	10
00050310783	14	52,0	10
00050311983	14	140,0	10
00050310883	17	60,0	10
00050310983	19	60,0	10

Bestell-No. Order-No.	AF	mm	
00050313283	3/16	52,0	10
00050313483	1/4	52,0	10
00050313683	5/16	52,0	10
00050313883	3/8	52,0	10
00050314083	7/16	52,0	10
00050314283	1/2	52,0	10
00050314483	9/16	60,0	10
00050315083	3/4	60,0	10

50-32 

Bestell-No. Order-No.	No.	mm	
00050320283	2	56,0	10
00050320383	3	56,0	10
00050320483	4	56,0	10

Expert



67-50-M 67-52-AF 67-80-M Werkzeugsortiment Expert „75 Jahre Edition“ Tool Set Expert „75 Years Edition“

Der Werkzeugkoffer mit der besonderen Ausstattung
The tool set with the exceptional configuration



- Bis zu 30 kg belastbarer Doppelaluminiumrahmen, mit Kippzylinderschloss
- Maße: 480 x 320 x 150 mm
- Twin-aluminium frame, resilient up to 30 kg, with tip cylinder lock
- Dimensions: 480 x 320 x 150 mm



- Sicherer Halt der Werkzeuge beim Transport durch hochwertige Schaumstoffeinlage
- Secure locking of tools at transport through high grade foam inlay



- Inklusive herausnehmbarer 1/4" Steckschlüssel-Garnitur, 17-teilig
- Including detachable 1/4" socket set, 17 pcs.

Bestell-No.
Order-No.

00067500082
00067520082
00067800082

Expert „75 Jahre Edition“ Lieferbar mit Steckschlüssel-Einsätzen

Expert „75 Years Edition“ Available with sockets

67-50-M 12-Kt. / 12-point

57 58

Code	No.	tlg./pcs.			EAN
00067500082	67-50-M-CP	77	11656	1	377217

67-52-AF

Code	No.	tlg./pcs.			EAN
00067520082	67-52-AF	77	11741	1	388046

wie/as 67-50-M, jedoch/but

Stck./pcs.	Artikel/article	No.	Maße/dimensions
12		50-12 AF	AF 3/8" / 7/16" / 1/2" / 9/16" / 19/32" / 5/8" / 11/16" / 3/4" / 13/16" / 7/8" / 15/16" / 1"
13		400 AF	AF 1/4" / 5/16" / 3/8" / 7/16" / 1/2" / 9/16" / 19/32" / 5/8" / 11/16" / 3/4" / 7/8" / 15/16" / 1"
1		27-4010 AF	AF 1"
8		1340 AF	AF 5/64" / 3/32" / 1/8" / 5/32" / 3/16" / 1/4" / 5/16" / 3/8"

67-80-M 6-Kt. / hexagon

Code	No.	tlg./pcs.			EAN
00067800082	67-80-M-CP	77	11741	1	377224

wie/as 67-50-M, jedoch/but

Stck./pcs.	Artikel/article	No.	Maße/dimensions
12		50-6 CPP	MM 10 11 12 13 14 15 16 17 19 21 22 24

Chrom-Vanadium
CP = verchromt, teilweise poliert
Chrome-Vanadium
CP = chromium plated, partly polished

In hochwertigem Kunststoffkoffer ABS
480 x 320 x 150 mm
In a high grade ABS case
480 x 320 x 150 mm



67-50-M enthaltend/containing			
Stck./pcs.	Artikel/article	No.	Maße/dimensions
12		50-12 CPP	MM 10 11 12 13 14 15 16 17 19 21 22 24
1		50-00-10 CPP	275 mm
1		50-04 CPP	125 mm
1		50-05 CPP	250 mm
1		50-06 CPP	80 mm
2		50-19-1	20,8 mm / 5/8 AF
1		300 CPI	240 mm
13		400 CP	MM 6 8 10 11 12 13 14 15 16 17 19 22 24
1		1200 CPI	180 mm
1		1213 CPI	160 mm
8		1340 B	MM 2 2.5 3 4 5 6 8 10
8		1348 B	T 9 10 15 20 25 27 30 40
1		1424 N	3 x 65 mm
1		1520 LS	300 g
1		1664 ST	18 mm
1		1721 ST	110 mm, 1W
1		1840-5 ST	5 m
2		4511 C	PH No. 1 2
2		4530 C	5,5 x 100 mm 8,0 150 mm
12		25-6	MM 4 4,5 5 5,5 6 7 8 9 10 11 12 13
1		25-00-10	140 mm
1		25-03	115 mm
1		25-04	50 mm
1		25-05-1	150 mm
1		25-06	35 mm
1		25-08	145 mm

50-33

Bestell-No. Order-No.	für Schrauben for screws	← L → mm	
00050330183	M 5	52,0	10
00050330283	M 6	52,0	10
00050330383	M 8	53,0	10
00050330483	M 8	100,0	10
00050330583	M 10	53,0	10
00050330683	M 10	120,0	10
00050330783	M 12	55,0	10
00050330883	M 12	100,0	10
00050331183	M 12	140,0	10
00050330983	M 14	58,0	10
00050331083	M 16	60,0	10

50-34

Bestell-No. Order-No.	für Schrauben for screws	← L → mm	
00050340183	M 5	63,0	10
00050340283	M 6	63,0	10
00050340383	M 8	63,0	10
00050340483	M 10	63,0	10
00050340583	M 12	63,0	10
00050340683	M 14	63,0	10
00050340783	M 16	63,0	10

50-35

Bestell-No. Order-No.	No.	← L → mm	
00050350283	2	56,0	10
00050350383	3	56,0	10
00050350483	4	56,0	10

50-36

Bestell-No. Order-No.	Größe / size	mm	← L → mm	
00050362083	T 20	3,86	55,0	10
00050362583	T 25	4,43	55,0	10
00050362783	T 27	4,99	55,0	10
00050363083	T 30	5,52	55,0	10
00050364083	T 40	6,65	55,0	10
00050364183	T 40	6,65	120,0	10
00050364583	T 45	7,82	55,0	10
00050364683	T 45	7,82	120,0	10
00050365083	T 50	8,83	58,0	10
00050365183	T 50	8,83	140,0	10
00050365583	T 55	11,22	58,0	10
00050365683	T 55	11,22	140,0	10
00050366083	T 60	13,25	58,0	10

50-78 - 50-79

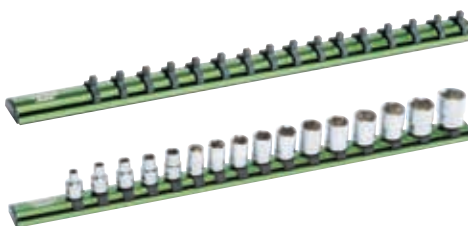

Bestell-No. Order-No.	No.	MM	tlg./pcs.		
98710501600		leer/empty	1	301	1
00050780083	50-78-M	SP 10 - 32	16	1841	1
00050790083	50-79-M	SP 10 - 32	16	1716	1

50-50



Bestell-No. Order-No.	No.	Größe / size E T	tlg./pcs.	
00050500083	50-50-E/T	10 - 24 25 - 60	16	1

50-55-2 50-58



Bestell-No. Order-No.	No.	MM	T	tlg./pcs.	
00050550283	50-55-2-M	MM 5 - 17	8	1	
00050580083	50-58	T 25 - T 60	8	1	

50-65 - 50-77



Bestell-No. Order-No.	No.	tlg./pcs.	
00050650083	50-65-M	325	1
00050750083	50-75-M	258	1
00050760083	50-76-M	258	1
00050770083	50-77-AF	266	1

Kombi-Spender, leer und Zubehör Dispensers, empty and Accessories

50-80 - 50-80-40

Bestell-No. Order-No.	No.	tlg./pcs.	
00050800100	50-80-1		
00050800200	50-80-2		
00050800300	50-80-3		
00050800400	50-80-4		
00050800020	50-80		
00050801060	50-80-10		
00050802060	50-80-20		
00050803020	50-80-30		
00050804000	50-80-40		

50-85 - 50-87 / 50-95 - 50-97



Bestell-No. Order-No.	No.	tlg./pcs.	
00050850083	50-85-M	102	1
00050860083	50-86-M	102	1
00050870083	50-87-AF	109	1
00050950083	50-95-M	278	1
00050960083	50-96-M	278	1
00050970083	50-97-AF	294	1

Einsatzspender, leer Socket Dispensers, empty

50-90 - 50-100

Bestell-No. Order-No.	No.	für/for No.
00050900020	50-90	50-85 - 50-89
00050000120	50-100	50-95 - 50-99

57-0010



Bestell-No. Order-No.	No.	tlg./pcs.	
00057001083	57-0010	20	1

67-50 67-80 Expert „75 Jahre Edition“ / „75 Years Edition“



Chrom-Vanadium
CP = verchromt, teilweise poliert

Chrome-Vanadium
CP = chromium plated, partly polished

In hochwertigem Kunststoffkoffer ABS 480 x 320 x 150 mm
In a high grade ABS case 480 x 320 x 150 mm

75 Jahre Edition
HEYCO
seventy-five years edition

Bestell-No. Order-No.	No.	tlg./pcs.	
00067500082	67-50-M-CP	77	1
00067520082	67-52-AF	77	1
00067800082	67-80-M-CP	77	1

70-0 - 70-3010



Bestell-No. Order-No.	No.	tlg./pcs.	
00070001083	70-0010-M	15	1
00070000083	70-0-M	15	1
00070500083	70-50-M	15	1
00070301083	70-3010-M	15	1
00070300083	70-30-M	15	1
00070800083	70-80-M	15	1
00070101083	70-1010-AF	15	1

HEYCO



www.heyco-tools.de

Geht Nicht – Gibt es Nicht!

**Wir haben für Ihre Wünsche und
Ideen ein offenes Ohr**

Wenn spezielle Anwendungen besondere Werkzeuge erfordern, sind wir Ihr kompetenter Ansprechpartner. Dieser Herausforderung stellen wir uns und realisieren ökonomisch sinnvolle, technische Lösungen von der Idee bis zur Serienfertigung. Dabei verfügen wir über alle bedeutenden Fertigungsverfahren, die uns in die Lage versetzen, Ihre Wünsche und Ansprüche konsequent umzusetzen.

Fordern Sie uns heraus.



There's Nothing That Can't Be Done!

We always have an Ear for your Wishes and Ideas

When special applications require extraordinary tools, HEYCO is your competent partner. We will face any challenge in this field supporting economically reasonable technical solutions from the initial idea to volume production. We have access to all important production techniques enabling us to transform your wishes and requirements into reality.

Put us to test!



72-4010 - 72-4310

1/2 3/8

60



talenta

72-4310

Bestell-No. Order-No.	No.	tlg./pcs.		
00072401083	72-4010	21	1	
00072431083	72-4310	21	1	

73-03 - 73-3310

1/2

60 61



73-0310

Bestell-No. Order-No.	No.	tlg./pcs.		
00073030083	73-03-M	23	1	
00073330083	73-33-M	23	1	
00073031083	73-0310-M	23	1	
00073331083	73-3310-M	23	1	

75-0 - 75-3310

1/2

62 61



75-0010

Bestell-No. Order-No.	No.	tlg./pcs.		
00075001083	75-0010-M	24	1	
00075000083	75-0-M	24	1	
00075500083	75-50-M	24	1	
00075301083	75-3010-M	24	1	
00075300083	75-30-M	24	1	
00075800083	75-80-M	24	1	
00075101083	75-1010-AF	24	1	
00075100083	75-10-AF	24	1	
00075600083	75-60-AF	24	1	



75-0110

Bestell-No. Order-No.	No.	tlg./pcs.		
00075011083	75-0110-M	26	1	
00075311083	75-3110-M	26	1	



75-0310

Bestell-No. Order-No.	No.	tlg./pcs.		
00075031083	75-0310-M	23	1	
00075331083	75-3310-M	23	1	

76-0010

1/2

63



76-10

In hochwertiger Schaumstoffeinlage
In high quality foam insert

Bestell-No. Order-No.	No.	tlg./pcs.		
00076001083	76-0010-M	28	1	

77-0 77-30

1/2

64



77-0

Bestell-No. Order-No.	No.	tlg./pcs.		
00077000083	77-0-M	36	1	
00077300083	77-30-M	36	1	

78-0 - 78-3010

1/2

64



78-0010

Bestell-No. Order-No.	No.	tlg./pcs.		
00078001083	78-0010-M	18	1	
00078000083	78-0-M	18	1	
00078301083	78-3010-M	18	1	
00078300083	78-30-M	18	1	

79-0010 - 79-3310

1/2

65



79-0010

Bestell-No. Order-No.	No.	tlg./pcs.		
00079001083	79-0010-M	32	1	
00079301083	79-3010-M	32	1	
00079031083	79-0310-M	32	1	
00079331083	79-3310-M	32	1	

84-0010

1/4 1/2

65



84-0010

In hochwertiger Schaumstoffeinlage
In high quality foam insert

Bestell-No. Order-No.	No.	tlg./pcs.		
00084001083	84-0010-M	23	1	

84-3010

1/4 1/2

66



84-3010

In hochwertiger Schaumstoffeinlage
In high quality foam insert

Bestell-No. Order-No.	No.	tlg./pcs.		
00084301083	84-3010-M	23	1	



94-2550

1/4 1/2

66



Bestell-No. Order-No.	No.	tlg./pcs.		
00094255000	94-2550-E/T	49	1	

100-00-5 - 100-16   

DIN 3122 + 3123

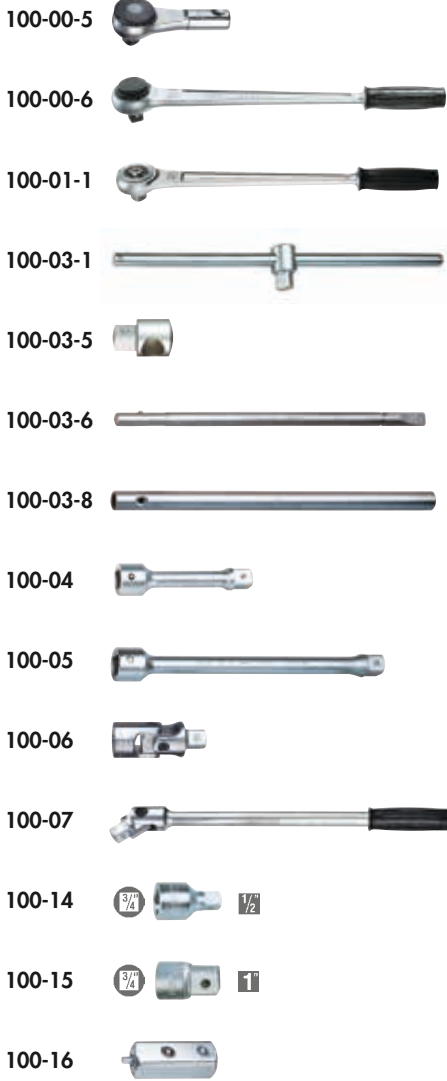

Bestell-No. Order-No.	No.	←L→ mm	
0010000580	100-00-5	165	2
0010000680	100-00-6	490	2
00100011080	100-01-1	490	2
00100030180	100-03-1	485	2
00100030580	100-03-5	59	2
00100030680	100-03-6	470	2
00100030880	100-03-8	475	2
00100040080	100-04	200	2
00100050080	100-05	400	2
00100060080	100-06	110	2
00100070080	100-07	500	2
00100140080	100-14	60	10
00100150080	100-15	60	10
00100160080	100-16	45	10

100-6   

DIN 3124
ISO 2725





Bestell-No. Order-No.	MM	
00100602280	22	5
00100602480	24	5
00100602780	27	5
00100603080	30	5
00100603280	32	5
00100603680	36	5
00100603880	38	5
00100604180	41	5
00100604680	46	5
00100605080	50	5
00100605580	55	5

100-12   

DIN 3124
ISO 2725





Bestell-No. Order-No.	MM	
00100002280	22	5
00100002480	24	5
00100002780	27	5
00100002980	29	5
00100003080	30	5
00100003280	32	5
00100003380	33	5
00100003680	36	5
00100003880	38	5
00100004180	41	5
00100004680	46	5
00100005080	50	5
00100005580	55	5
00100006080	60	5

Bestell-No. Order-No.	AF	
00100033480	7/8	5
00100033580	15/16	5
00100033780	1	5
00100033880	1.1/16	5
00100033980	1.1/8	5
00100034080	1.3/16	5
00100034180	1.1/4	5
00100034280	1.5/16	5
00100034380	1.3/8	5
00100034480	1.7/16	5
00100034580	1.1/2	5
00100034780	1.5/8	5
00100034880	1.11/16	5
00100034980	1.3/4	5
00100035080	1.13/16	5
00100035180	1.7/8	5
00100035280	2	5

101-0 - 101-80  





Bestell-No. Order-No.	No.	tlg./pcs.	
00101000080	101-0-M	14	1
00101500080	101-50-M	14	1
00101300080	101-30-M	14	1
00101800080	101-80-M	14	1
00101100080	101-10-AF	14	1
00101600080	101-60-AF	14	1

105-00-6 - 105-14   

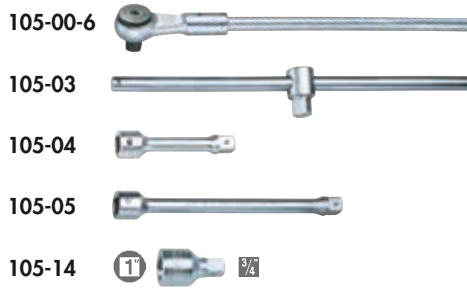
DIN 3122 + 3123





Bestell-No. Order-No.	No.	←L→ mm	
00105000680	105-00-6	640	1
00105030080	105-03	640	1
00105040080	105-04	205	2
00105050080	105-05	405	2
00105140080	105-14	80	2

105-12  

DIN 3124
ISO 2725



Bestell-No. Order-No.	MM	
00105003680	36	1
00105004180	41	1
00105004680	46	1
00105005080	50	1
00105005580	55	1
00105006080	60	1
00105006580	65	1
00105007080	70	1
00105007580	75	1
00105008080	80	1

Bestell-No. Order-No.	AF	
00105034480	1.7/16	1
00105034580	1.1/2	1
00105034780	1.5/8	1
00105035080	1.13/16	1
00105035280	2	1
00105035580	2.3/16	1
00105035680	2.1/4	1
00105035880	2.3/8	1
00105036280	2.5/8	1
00105036380	2.3/4	1
00105036780	3.1/8	1

106-0  



Bestell-No. Order-No.	No.	tlg./pcs.	
00106000080	106-0-M	14	1

3301-1  



Zur Aufnahme von Bits mit Außensechskant 1/4",
Klinge verchromt, mit 2-K Kunststoffheft
For bits 1/4"-drive, chromium plated,
with 2 component handle

Bestell-No. Order-No.	No.	←L→ mm	
03301010080	3301-1	200	10

3305  



Bestell-No. Order-No.	
03305000050	1

3310 $\frac{1}{2}$ $\frac{5}{16}$



Bestell-No. Order-No.	No.	tlg./pcs.	
0331000000	3310	13	1

3700 $\frac{3}{8}$ $\frac{5}{16}$ SP



Bestell-No. Order-No.	MM	
0370000636	6	10
0370000736	7	10
0370000836	8	10
0370000936	9	10
0370001036	10	10
0370001136	11	10
0370001236	12	10
0370001336	13	10
0370001436	14	10
0370001536	15	10
0370001636	16	10
0370001736	17	10
0370001836	18	10
0370001936	19	10
0370002036	20	10
0370002136	21	10
0370002236	22	10

3700-19 $\frac{3}{8}$ $\frac{5}{16}$ SP



Bestell-No. Order-No.	MM	
03700190736	7	10
03700190836	8	10
03700190936	9	10
03700191036	10	10
03700191136	11	10
03700191236	12	10
03700191336	13	10
03700191436	14	10
03700191536	15	10
03700191636	16	10
03700191736	17	10
03700191836	18	10
03700191936	19	10
03700192036	20	10
03700192136	21	10
03700192236	22	10

3704-15 - 3705-50 $\frac{3}{8}$ $\frac{3}{4}$



Bestell-No. Order-No.	No.	←L→ mm	
03704001536	3704-15	75	10
03704002536	3704-25	150	10
03705005036	3705-50	250	10

3800 $\frac{1}{2}$ SP



Bestell-No. Order-No.	MM	
03800001036	10	10
03800001136	11	10
03800001236	12	10
03800001336	13	10
03800001436	14	10
03800001536	15	10
03800001636	16	10
03800001736	17	10
03800001836	18	10
03800001936	19	10
03800002036	20	10
03800002136	21	10
03800002236	22	10
03800002336	23	10
03800002436	24	10
03800002536	25	10
03800002636	26	10
03800002736	27	10
03800002836	28	10
03800002936	29	10
03800003036	30	10
03800003236	32	10

3800-19 $\frac{1}{2}$ SP



Bestell-No. Order-No.	MM	
03800191036	10	10
03800191136	11	10
03800191236	12	10
03800191336	13	10
03800191436	14	10
03800191536	15	10
03800191636	16	10
03800191736	17	10
03800191836	18	10
03800191936	19	10
03800192036	20	10
03800192136	21	10
03800192236	22	10
03800192336	23	10
03800192436	24	10

3804-25 - 3805-50 $\frac{1}{2}$ $\frac{1}{2}$



Bestell-No. Order-No.	No.	←L→ mm	
03804002536	3804-25	50	10
03804005036	3804-50	125	10
03805005036	3805-50	250	10

3806-10 $\frac{1}{2}$ $\frac{1}{2}$



Bestell-No. Order-No.	No.	
03706001036	3706-10	10
03806001036	3806-10	10

3800-9015 $\frac{1}{2}$ SP



In hochwertiger Schaumstoffeinlage
In high quality foam insert

Bestell-No. Order-No.	No.	tlg./pcs.	
03800901536	3800-9015-M	15	1

IMPACT

6300 $\frac{1}{2}$ SP DIN 3129/ISO 2725



Bestell-No. Order-No.	MM	
06300000836	8	10
06300001036	10	10
06300001136	11	10
06300001236	12	10
06300001336	13	10
06300001436	14	10
06300001536	15	10
06300001636	16	10
06300001736	17	10
06300001836	18	10
06300001936	19	10
06300002036	20	10
06300002136	21	10
06300002236	22	10
06300002336	23	10
06300002436	24	10
06300002736	27	10
06300003036	30	10
06300003236	32	10
06300003336	33	10
06300003436	34	10

Bestell-No. Order-No.	AF	
06300032136	7/16	10
06300032336	1/2	10
06300032536	9/16	10
06300032736	5/8	10
06300032936	11/16	10
06300033136	3/4	10
06300033336	13/16	10
06300033436	7/8	10
06300033536	15/16	10
06300033736	1	10
06300033836	1.1/16	10
06300033936	1.1/8	10
06300034236	1.1/4	10
06300034136	1.5/16	10

6300-19 $\frac{1}{2}$ SP

Bestell-No. Order-No.	MM	
06300190836	8	10
06300191036	10	10
06300191336	13	10
06300191436	14	10
06300191636	16	10
06300191736	17	10
06300191836	18	10
06300191936	19	10
06300192136	21	10
06300192236	22	10
06300192336	23	10
06300192436	24	10
06300192736	27	10
06300193036	30	10
06300193236	32	10

Lieferbar ab Juli 2015. Available from July 2015.

Bestell-No. Order-No.	MM		
06300181736	17		10
06300181936	19	Neu New	10
06300182136	21		10
06300182236	22		10

Bestell-No. Order-No.	MM		
06300310236	5	60 mm	10
06300310336	6		10
06300310436	8		10
06300310536	10		10
06300310636	12		10
06300310736	14		10
06300310836	17		10
06300310936	19	10	

Bestell-No. Order-No.	mm		
06300201036	E 10	Neu New	10
06300201236	E 12		10
06300201436	E 14		10
06300201636	E 16		10
06300201836	E 18		10
06300202036	E 20		10
06300202436	E 24		10

Bestell-No. Order-No.	mm		
06300363036	T 30	60 mm	10
06300364036	T 40		10
06300364536	T 45		10
06300365036	T 50		10
06300367036	T 60		10
06300366036	T 70		10

6500 $\frac{3}{4}$ SP

DIN 3129/ISO 2725

Bestell-No. Order-No.	MM		
06500001736	17	Neu New	10
06500001836	18		10
06500001936	19		10
06500002236	22		10
06500002436	24		10
06500002736	27		10
06500003036	30		10
06500003236	32		10
06500003336	33		10
06500003436	34		10
06500003636	36		10
06500003836	38		10
06500004136	41		10
06500004636	46		10

Bestell-No. Order-No.	AF		
06500033436	7/8	Neu New	10
06500033536	15/16		10
06500033736	1		10
06500033836	1.1/16		10
06500033936	1.1/8		10
06500034136	1.1/4		10
06500034236	1.5/16		10
06500034336	1.3/8		10
06500034436	1.7/16		10
06500034536	1.1/2		10
06500034736	1.5/8		10
06500034836	1.11/16		10
06500034936	1.3/4		10
06500035236	1.7/8		10
06500035136	2		10

Bestell-No. Order-No.	MM		
06500191736	17		10
06500191936	19		10
06500192136	21		10
06500192236	22		10
065001921436	24		10
06500192736	27		10
06500193036	30		10
06500193236	32		10
06500193336	33		10
06500193436	34		10
06500193636	36		10
06500193836	38		10
06500194136	41		10
06500194636	46		10

Bestell-No. Order-No.	MM		
06500310736	14	90 mm	10
06500310836	17		10
06500310936	19		10
06500312036	22		10
06500312136	24		10
06500312236	27		10

6600 T1 SP

DIN 3129/ISO 2725

Bestell-No. Order-No.	MM		
06600001936	19		10
06600002436	24		10
06600002736	27		10
06600003036	30		10
06600003236	32		10
06600003336	33		10
06600003436	34		10
06600003636	36		10
06600003836	38		10
06600004136	41		10
06600004236	42		10
06600004636	46		10
06600005036	50		10
06600005536	55		10
06600006036	60		10
06600006536	65		10
06600007036	70		10
06600007536	75		10
06600008036	80	10	

Bestell-No. Order-No.	AF		
06600033736	1	Neu New	10
06600034136	1.1/4		10
06600034436	1.7/16		10
06600034536	1.1/2		10
06600034736	1.5/8		10
06600035036	1.13/16		10
06600035136	1.7/8		10
06600035636	2.1/4		10

Bestell-No. Order-No.	MM		
06600192236	22		10
06600192436	24		10
06600192736	27		10
06600193036	30		10
06600193236	32		10
06600193336	33		10
06600193436	34		10
06600193636	36		10
06600193836	38		10
06600194136	41		10
06600194636	46		10
06600195036	50		10
06600195536	55		10

Bestell-No. Order-No.	MM		
06600310936	19	100 mm	10
06600312036	22		10
06600312136	24		10
06600312236	27		10
06600312336	30		10
06600312436	32		10

6300-19 $\frac{1}{2}$ SP

Bestell-No. Order-No.	No.	tlg./pcs.	
06300901136	6300-19-M	10	1

In hochwertiger Schaumstoffeinlage
In high quality foam insert

6301-1 - 6601-5

DIN 3121/ISO 1174



6301-1 - 6301-4 $\frac{1}{2}$ $\frac{1}{2}$

Bestell-No. Order-No.	No.	L mm	
06301001236	6301-2	125	10
06301001436	6301-4	250	10

6501-3 - 6501-5 $\frac{3}{4}$ $\frac{3}{4}$

Bestell-No. Order-No.	No.	L mm	
06501001336	6501-3	175	5
06501001436	6501-4	250	5
06501001536	6501-5	330	5

6601-3 - 6601-5 T1 T1

Bestell-No. Order-No.	No.	L mm	
06601001336	6601-3	175	5
06601001436	6601-4	250	5
06601001536	6601-5	330	2

6301-10 - 6601-10

DIN 3121 ISO 1174



Bestell-No. Order-No.	No.		
06301001036	6301-10	$\frac{1}{2}$ $\frac{1}{2}$	10
06501001036	6501-10	$\frac{3}{4}$ $\frac{3}{4}$	5
06601001036	6601-10	T1 T1	5

6301-20 - 6601-20

DIN 3121 ISO 1174



Bestell-No. Order-No.	No.			
06301002236	6301-22	1/2	3/4	10
06501002036	6501-20	3/4	1/2	10
06501002236	6501-22	3/4	1	10
06601002036	6601-20	1	3/4	5

6301-40-1 - 6601-40



Bestell-No. Order-No.	No.	für/for	MM	
06301104000	6301-40-1	1/2	4 x 19	20
06301204000	6301-40-2	1/2	4 x 24	20
06501004000	6501-40	3/4	5 x 36	20
06601004000	6601-40	1	7 x 45	20

6301-41-1 - 6601-41



Bestell-No. Order-No.	No.	für/for	MM	
06301104136	6301-41-1	1/2	3 x 20	20
06301204136	6301-41-2	1/2	3 x 25	20
06501004136	6501-41	3/4	4 x 35	20
06601004136	6601-41	1	5 x 45	20

6700 IMPACT Werkzeuggarnitur für Druckluftantrieb / IMPACT Tool set for operation with compressed air



Bestell-No. Order-No.	No.	Inhalt Content	← L → mm mm	
06700904200	6700	45-tlg./pcs.		1
			3/8"x10 1/2"x10 1/2"x14	
	30	RI	5/6/7/8/10/12 75 9/10/13/14	
	30	M	5/6/8/10 75 12/14	
	75	M	16	
	30	HW	4/5/6/7/8/10/12 75 13/14/17/19	
	30	TX	20/25/30/40/45	
	75	TX	40/55/60/90/100	
	75	TTX	70/80	

Ersatzteile/Spare parts

Bestell-No. Order-No.	← L → mm mm	
06740001036	3/8"x10	1
06750001036	1/2"x10	1
06750001436	1/2"x14	1
06710362005	30 TX20	1
06710362505	30 TX25	1
06710363005	30 TX30	1
06710364005	30 TX40	1
06710364505	30 TX45	1
06710330505	30 M5	1
06710330605	30 M6	1
06710330805	30 M8	1
06710331005	30 M10	1
06710340505	30 RI5	10 mm 1
06710340605	30 RI6	10 mm 1
06710340705	30 RI7	10 mm 1
06710340805	30 RI8	10 mm 1
06710341005	30 RI10	10 mm 1
06710341205	30 RI12	10 mm 1
06710300405	30 4	1
06710300505	30 5	1
06710300605	30 6	1
06710300705	30 7	1
06710300805	30 8	1
06710301005	30 10	1
06710301205	30 12	1
06715364005	75 TX40	1
06715365505	75 TX55	10 mm 1
06715331205	75 M12	10 mm 1
06715340905	75 RI9	10 mm 1
06715341005	75 RI10	10 mm 1
06720360605	75 TX60	1
06720360905	75 TX90	1
06720361005	75 TX100	1
06720360705	75 TTX70	1
06720360805	75 TTX80	14 mm 1
06720331405	75 M14	14 mm 1
06720331605	75 M16	14 mm 1
06720341305	75 RI13	14 mm 1
06720341405	75 RI14	14 mm 1
06720301305	75 13	1
06720301405	75 14	1
06720301705	75 17	1
06720301905	75 19	1

Drehmomentschlüssel Torque Wrenches

664 - 796

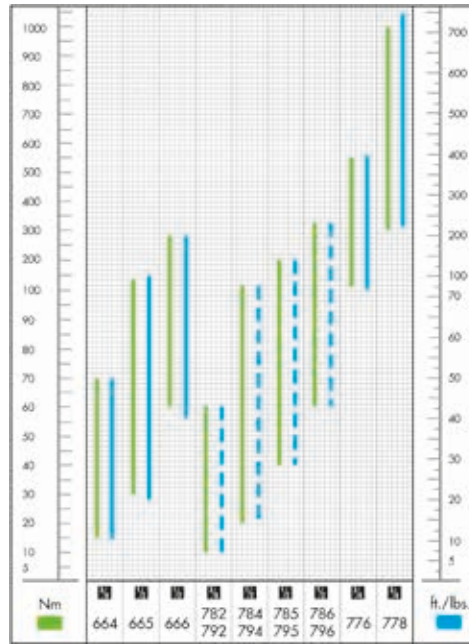

664 - 666

Bestell-No. Order-No.	No.	Nm	ft./lbs.	
00664000083	664	3/8 15-70	10-50	1
00665000083	665	1/2 30-140	20-100	1
00666000083	666	1/2 60-280	40-200	1

762 - 766

Bestell-No. Order-No.	No.	Nm	
00762200080	762	1/4"+3/8" 12- 60	1
*00764200080	764	1/2" 27-135	1
*00765200080	765	1/2" 40-200	1
*00766200080	766	1/2" 68-340	1

* Mit integrierter Drehwinkelmessung
With integrated angle measurement

782 - 786 DIN · ISO 6789

Bestell-No. Order-No.	No.	Nm	
00782000080	782	3/8 10- 60	1
00784000080	784	1/2 20-120	1
00785000080	785	1/2 40-200	1
00786000080	786	1/2 60-320	1

792 - 796 DIN · ISO 6789

Bestell-No. Order-No.	No.	Nm	Einsteckvierkant/ plug mm	
00792000080	792	10-60	9x12	1
00794000080	794	20-120	14x18	1
00795000080	795	40-200	14x18	1
00796000080	796	60-320	14x18	1

792-10 794-10

Bestell-No. Order-No.	No.	für/for No.	
00792100083	792-10	3/8 792	1
00794100083	794-10	1/2 794, 795, 796	1

792-21 794-21

Bestell-No. Order-No.	No.	für/for No.	
00792210080	792-21	3/8 792	1
00794210080	794-21	1/2 794, 795, 796	1

792-31 794-31

Bestell-No. Order-No.	No.	für/for No.	
00792310880	8		1
00792310980	9		1
00792311080	10		1
00792311180	11		1
00792311280	12		1
00792311380	13		1
00792311480	792-31 14	792	1
00792311580	15		1
00792311680	16		1
00792311780	17		1
00792311880	18		1
00792311980	19		1

Bestell-No. Order-No.	No.	ØMM	für/for No.	
00794311380	13			1
00794311480	14			1
00794311580	15			1
00794311680	16			1
00794311780	17		794	1
00794311880	18		+	1
00794311980	19		795	1
00794312180	21		+	1
00794312280	22		796	1
00794312480	24			1
00794312780	27			1
00794313080	30			1
00794313280	32			1
00794313480	34			1

792-41 794-41



Bestell-No. Order-No.	No.	ØMM	für/for No.	
00792410880	8			1
00792411080	10			1
00792411180	11			1
00792411280	12			1
00792411380	13			1
00792411480	14			1
00792411580	15		792	1
00792411680	16			1
00792411780	17			1
00792411880	18			1
00792411980	19			1
00792412180	21			1
00792412280	22			1

Bestell-No. Order-No.	No.	ØMM	für/for No.	
00794411380	13			1
00794411480	14			1
00794411580	15			1
00794411680	16			1
00794411780	17		794	1
00794411880	18		+	1
00794411980	19		795	1
00794412180	21		+	1
00794412280	22		796	1
00794412480	24			1
00794412780	27			1
00794413080	30			1
00794413280	32			1
00794413480	34			1

792-51



Bestell-No. Order-No.	No.	ØMM	für/for No.	
00792511080	10			1
00792511180	11			1
00792511280	12			1
00792511380	13			1
00792511480	14			1
00792511680	16		792	1
00792511780	17			1
00792511880	18			1
00792511980	19			1
00792512180	21			1
00792512280	22			1

792-18



Bestell-No. Order-No.	No.	tlg./pcs.	Einsteckvierkant/ plug mm	
00792180080	792-18	18	9 x 12	1

795-20

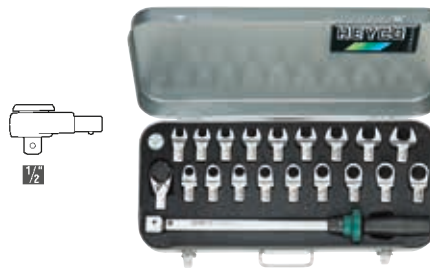

Bestell-No. Order-No.	No.	tlg./pcs.	Einsteckvierkant/ plug mm	
00795200080	795-20	20	14 x 18	1

776 DIN · ISO 6789



Bestell-No. Order-No.	No.	■	Nm	lbf-ft	
00776000000	776	3/4"	110 - 550	80 - 400	1

778 DIN · ISO 6789



Bestell-No. Order-No.	No.	■	Nm	lbf-ft	
00778000000	778	3/4"	300 - 1000	220 - 750	1

779



Bestell-No. Order-No.	No.	■	Nm	
00779100000	779	3/4"+1"	max. 2700	1

695-1



Bestell-No. Order-No.	◊°	
00695101000	0 - 360	1

501



Bestell-No. Order-No.	ØMM / ØAF	
00501242736	MM 24 x 27	1
00501273236	MM 27 x 32	1
00501242736	AF 15/16 x 1.1/16	1
00501273236	AF 1.1/16 x 1.1/4	1

503



Bestell-No. Order-No.	ØMM/AF	
00503665636	AF 1.1/8 x 13/16 □ x 1.1/2	1
00503666436	AF 1.5/16 x 13/16 □ x 1.1/2	1

510



Bestell-No. Order-No.	ØMM	
00510101237	12	5
00510101437	14	5
00510101937	19	5
00510102437	24	2
00510103237	32	2
00510103637	36	1

600-10



Bestell-No. Order-No.	ØMM/AF	
00600001082	MM 17 x 19 x 22 x AF 11/16	1

HEYCO



www.heyco-tools.de



Spezialrohrschlüssel zum Entlüften und Entnahme der Bremsflüssigkeit mit integriertem Tropfstopp.

Ermöglicht das Öffnen und Schließen des Entnahmenippels an der Radbremse auf engstem Raum. Der integrierte Tropfstopp verhindert das Auslaufen der Bremsflüssigkeit nach dem Abziehen des Rohrschlüssels.

Die Betätigung erfolgt über einen Ringschlüssel, der auch bei aufgestecktem Entnahmeschlauch/Rohrschlüssel problemlos umgesetzt werden kann. Das im Spezialrohrschlüssel und im Entnahmebehälter integrierte Rückschlagventil verhindert bei geöffneter Leitung den ungewollten Rücklauf und das Eindringen von Luft.

Erhebliche Zeiteinsparung beim Wechsel der Bremsflüssigkeit und dem Entlüften des Bremsystems. Lästiges, ständiges Öffnen und Schließen der Bremsanlage am Rad entfällt.

Zusätzlich verhindert das geschlossene System das unbeabsichtigte Auslaufen von Bremsflüssigkeit.

Werkzeugsatz mit 5 Schlüsselweiten von 7 -11 mm in einer kurzen und langen Version (48 mm + 124 mm) deckt sämtliche Einsatzbereiche an allen gängigen Fahrzeugtypen ab.

Gebrauchsmusterschutz
utility model protection

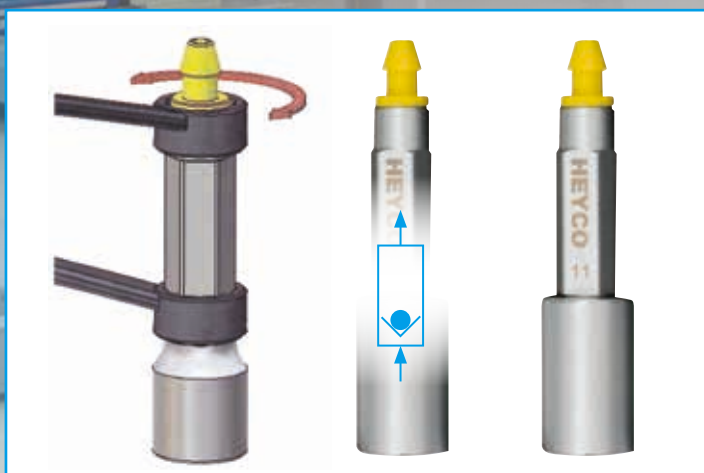



Special Pipe Wrench for Venting and Removal of Brake Fluid with integrated Drip Stop.

Allows for opening and shutting of the drain nipple on the wheel brake in confined spaces.
The integrated drip stop prevents leakage of brake fluid after removal of the pipe wrench.

The actuation is effected by a ring wrench. Its position can be altered without difficulty even with the drain tube/pipe wrench attached.
The special pipe wrench as well as the container have integrated check valves preventing unwanted reflux and air intrusion even with the pipe opened.

Considerable saving of time when changing brake fluid or venting the braking system. No permanent and cumbersome opening and shutting of the wheel braking system.
Additionally, the closed system prevents leakage of brake fluid.

Tool set with 5 wrench sizes (7 - 11 mm) including a short and a long version (48 and 124 mm) covers all applications on all common types of cars.

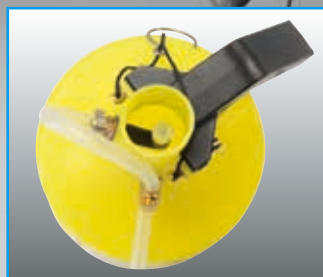
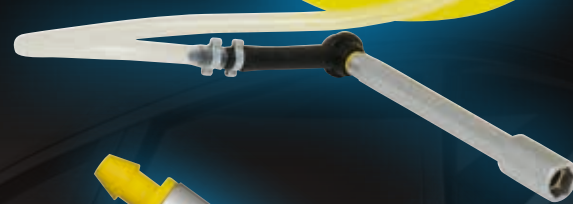

610   AF 13/16 



Bestell-No. Order-No.	No.	MM/AF	
00610001070	610-1	MM 24x27x30x32	1
00610002070	610-2	MM 24x27x32x38	1
00610003170	610-31	MM 19x22x24x27	1
00610002070	610-4	AF 15/16x1.1/16x1.1/4x1.1/2	1
00610003170	610-8	AF 3/4x7/8x15/16x1.1/16	1
00610010070	610-10	MM 24 x 27 x 32 x $\frac{3}{4}$	1
00610003070	610-30	MM 27 x 30 x 32 x $\frac{3}{4}$	1

530 



Bestell-No. Order-No.	MM	
00530060780	6 x 7	10
00530080980	8 x 9	10
00530101180	10 x 11	10
00530121380	12 x 13	10
00530141580	14 x 15	5
00530161780	16 x 17	5
00530181980	18 x 19	5
00530202280	20 x 22	5
00530212380	21 x 23	5
00530242680	24 x 26	5
00530242780	24 x 27	5
00530252880	25 x 28	5
00530303280	30 x 32	5

B 530 



Bestell-No. Order-No.	No.	MM	
00530644080	B 530-8-M	6 - 22 + 1360	1
00530647080	B 530-12-M	6 - 32 + 1360	1
00530647180	B 530-12-M-1	6 - 32 + 1360	1

K 530 



Bestell-No. Order-No.	No.	MM	
00530944080	K 530-8-M	6 - 22	1
00530947080	K 530-12-M	6 - 32	1
00530947180	K 530-12-M-1	6 - 32	1

531 Werkzeugsatz für die Bremsflüssigkeitsentnahme / Tool Set for Brake Fluid Extraction

Neu
New



- Ermöglicht das Öffnen und Schließen des Entnahmenippels an der Radbremse auf engstem Raum
- Der integrierte Tropfstopp verhindert das Auslaufen der Bremsflüssigkeit nach dem Abziehen des Rohrschlüssels
- Erhebliche Zeitersparung beim Wechsel der Bremsflüssigkeit und Entlüften des Bremssystems
- Allows for opening and shutting of the drain nipple on the wheel brake in confined spaces
- The integrated drip stop prevents leakage of brake fluid after removal of the pipe wrench
- Considerable saving of time when changing brake fluid or venting the brake system



Bestell-No. Order-No.	No.	
00531010080	531	10-tlg. / pcs. 1

enthaltend/containing

Bestell-No. Order-No.	MM	← L → mm
00531700080	7	48
00531800080	8	48
00531900080	9	48
00531100080	10	48
00531110080	11	48
00531907080	7	124
00531908080	8	124
00531909080	9	124
00531910080	10	124
00531911080	11	124

531-19 Bremsenentlüftungs-schlüssel, Länge 48 mm / Brake Venting Wrench, Length 48 mm



Neu
New

Bestell-No. Order-No.	MM	← L → mm	
00531700080	7	48	10
00531800080	8	48	10
00531900080	9	48	10
00531100080	10	48	10
00531110080	11	48	10

531-19 Bremsenentlüftungs-schlüssel, Länge 124 mm / Brake Venting Wrench, Length 124 mm



Neu
New

Bestell-No. Order-No.	MM	← L → mm	
00531907080	7	124	10
00531908080	8	124	10
00531909080	9	124	10
00531910080	10	124	10
00531911080	11	124	10

531-5-1 Entnahmebehälter für Bremsflüssigkeit (1 Schlauch) / Draining Container for Brake Fluid (1 Tube)

1,3L

Neu
New



- Glasfaserverstärkter Kunststoff
- Schlagfest
- 1,3 L Fassungsvermögen
- Eingebautes Rückschlagventil
- Transparenter Silikon Schlauch, hochflexibel
- Temperaturunempfindlich
- Aufhängemöglichkeit am Fahrzeug
- Eingebaute Zugentlastung
- Korrosionsbeständige Verschraubungen
- Verschlusskappe
- Durchsichtiger Behälter mit Füllstandsanzeige in ml
- Glass-Fibre reinforced plastic
- Impact-Proof
- Capacity 1.3 l
- Built-In check valve
- Transparent silicon tube, highly flexible
- Temperature-Immune
- Hanger for use on vehicles
- Built-In strain relief
- Corrosion-Proof fittings
- Closing cap
- Transparent container with level indicator (ml)

Bestell-No. Order-No.	L	
00531511300	1,3	1

531-5-2 Entnahmebehälter für Bremsflüssigkeit (2 Schläuche) / Draining Container for Brake Fluid (2 Tubes)

1,3L

Neu
New



Bestell-No. Order-No.	L	
00531521300	1,3	1

896 DIN 896 B



 95

Bestell-No. Order-No.	ØMM	
00896060780	6 x 7	10
00896080980	8 x 9	10
00896081080	8 x 10	10
00896101180	10 x 11	10
00896121380	12 x 13	10
00896141580	14 x 15	10
00896161780	16 x 17	5
00896171980	17 x 19	5
00896181980	18 x 19	5
00896202280	20 x 22	5
00896212380	21 x 23	5
00896242680	24 x 26	5
00896242780	24 x 27	5
00896252880	25 x 28	5
00896303280	30 x 32	5
00896323680	32 x 36	1
00896364180	36 x 41	1
00896414680	41 x 46	1
00896465080	46 x 50	1
00896505580	50 x 55	1
00896556080	55 x 60	1

K 896

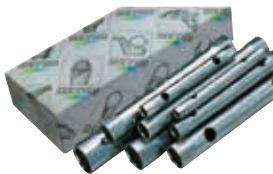

 95

Bestell-No. Order-No.	No.	ØMM	
00896944080	K 896-8-M	6-22	1
00896947080	K 896-12-M	6-32	1

R 896-9



Mit Drehstange in Rolltasche
With Tommy bar in wallet

Bestell-No. Order-No.	No.	ØMM	
00896744080	R 896-9-M	6-22 6x7 8x9 10x11 12x13 14x15 16x17 17x19 20x22	1

900



 96

Bestell-No. Order-No.	No.	Ømm	
00900000305	900-3	3,2	10
00900000405	900-4	4	10
00900000505	900-5	5	10
00900000605	900-6	6	10
00900000805	900-8	8	10
00900001005	900-10	10	10
00900001205	900-12	12	10
00900001405	900-14	14	5
00900001605	900-16	16	5
00900001805	900-18	18	5
00900002005	900-20	20	5

1360



 96

Bestell-No. Order-No.	Ømm	
01360028080	3,2 5 6 8 10 12	10

541



 96

Bestell-No. Order-No.	ØMM	
00541000583	5	10
00541000583	5,5	10
00541000683	6	10
00541000783	7	10
00541000883	8	10
00541001083	10	10

545





 96

Bestell-No. Order-No.	ØMM	
00545000600	6	10
00545000700	7	10

Werkzeugsortimente in Kartonagen Tool Assortments (in cardboard cartons only)

910 - 943



Bestell-No. Order-No.	No.	tlg./pcs.		
00910000282	910-M	89	89	1
00910000382	910-AF	89	89	1
00911000282	911-M	113	90/91	1
00911000382	911-AF	113	90/91	1
00933000282	933-M	110	100/101	1
00933000382	933-AF	108	100/101	1
00942000282	942-M	140	102/103	1
00942000382	942-AF	135	102/103	1
00943000282	943-M	165	104/105	1
00943000382	943-AF	156	104/105	1

1000 1002

 98

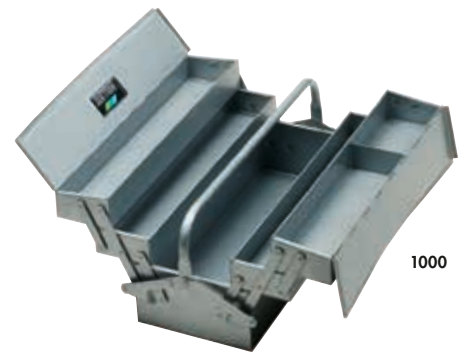

1000

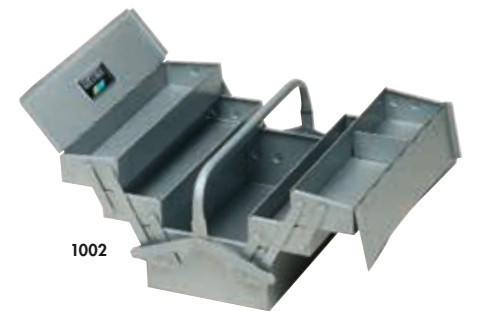

1002

Bestell-No. Order-No.	No.	Maße/ dimensions	Fächer/ trays	
01000010020	1000	530 x 200 x 200 mm	5	1
01002010020	1002	420 x 200 x 200 mm	5	1

1000-914-M Werkzeugsortiment im Werkzeugkasten, 100-tlg. / Mechanics' Tool Set, 100-pcs. Neu New



Leerer Werkzeugkasten
Verstellbarer Einmaulschlüssel 8" / 205 mm
Magnetschlüsselsatz 4 - 7,5 mm
Doppellingschlüssel: 6x7/8x9/10x11/12x13/14x15/16x17/18x19/20x22/21x23/24x26/25x28/27x32 mm
Montiereten 500 mm
Flachmeißel 200 x 25 mm
Kreuzmeißel 150 x 6 mm
Durchtreiber 120 / 2 mm
Körner 120 / 4 mm
Universal-Gripzange 250 mm
Zündkerzensatz 20,8 mm
Vergaser Schraubendreher 25 x 4
Schraubendreher für Schlitzschrauben 150 x 8
Schraubendreher für Schlitzschrauben 200 x 10
Kreuzschlitzschraubendreher No. 01 / 1 / 2 "Phillips" Socket 1/2": 10,11,12,13,14,15,16,17,18,19,20,21,22,23,24,26,27,28,30,32
Kurbel 1/2"
Gelenkgriff 1/2"
Griff mit Gleitstück 1/2"
Hebelumschaltknarre 1/2"
Verlängerung 1/2" 125/250 mm
Kardangeln 1/2"
Seitenschneider 160 mm
Kombinationszange 180 mm
Kunststoffhammer Ø 35 mm
6-Kant Winkelschraubendrehersatz 2-10 mm
Flachstumpf-Feile 200 mm
Rund-Feile 200 mm
Dreikant-Feile 200 mm
Kontakt-Feile 150 mm
Drahtbürste 4-reihig
Schlosserhammer 500 gr.
Fühlerlehre 13-tlg. 0.05-1.0 mm
Prof-Bandmaß 5 m
Ölspritzkanne 250 ccm
Vorhängeschloss 40 mm
Metallsäge, verstellbar
Rohr- und Wasserpumpenzange 240 mm
Doppelmmaulschlüssel: 6x7/8x9/10x11/12x13/14x15/16x17/18x19/20x22/21x23/24x26/25x28/27x32 mm

Empty Tool Box
Adjustable Wrench 8" / 205 mm
Ignition Wrench Set 4 - 7,5 mm
D.E. Ring Wrench Set: 6x7/8x9/10x11/12x13/14x15/16x17/18x19/20x22/21x23/24x26/25x28/27x32 mm
Tyre Lever 500 mm
Flat Cold Chisel 200 x 25 mm
Cross Cut Chisel 150 x 6 mm
Drift Punch 120 / 2 mm
Centre Punch 120 / 4 mm
Universal Grip Plier 250 mm
Sparg Plug Socket 20,8 mm
Stubby Screwdriver 25 x 4
Slot Screwdriver 150 x 8
Slot Screwdriver 200 x 10
Crosst Slot Screwdriver No. 01 / 1 / 2 "Phillips" Socket 1/2": 10,11,12,13,14,15,16,17,18,19,20,21,22,23,24,26,27,28,30,32
Speed Brace 1/2"
Swivel Handle 1/2"
Sliding T-Handle 1/2"
Reversible Ratchet 1/2"
Extension Bar 1/2" 125/250 mm
Universal Joint 1/2"
Diagonal Side Cutting Nipper 160 mm
Combination Plier 180 mm
Plastic Hammer Ø 35 mm
Hexagonal Head Wrench Set 2-10 mm
Engineers Hand File 200 mm
Round File 200 mm
Threesquare File 200 mm
Contact File 150 mm
Wire Brush 4-rows
Engineers Hammer 500 gr.
Feeler Gauge 13-pcs. 0.05-1.0 mm
Professional Measuring Tape 5 m
Oil Can 250 ccm
Padlock 40 mm
Adj. Hacksaw Frame
Universal Plier, 240 mm
Double Ended Open Jaw Wrench: 6x7/8x9/10x11/12x13/14x15/16x17/18x19/20x22/21x23/24x26/25x28/27x32 mm

Bestell-No. Order-No.	tlg./pcs.	
01000091482	100	1

1101 98



Bestell-No. Order-No.	Maße/ dimensions	
01101010020	650 x 200 x 780 mm	1

1000-915-M Werkzeugsortiment im Werkzeugkasten, 100-tlg. / Mechanics' Tool Set, 100-pcs. Neu New

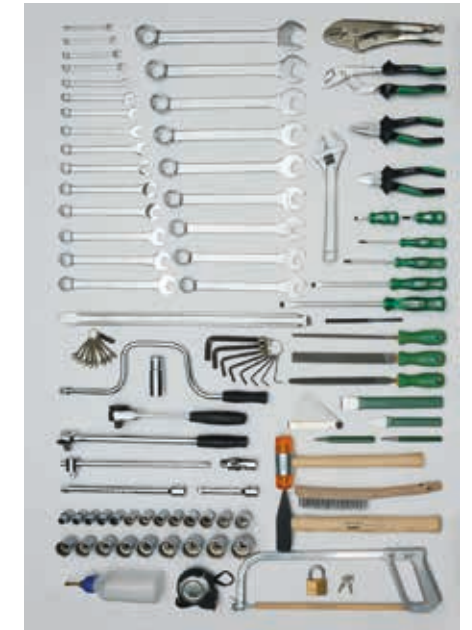

Leerer Werkzeugkasten
Verstellbarer Einmaulschlüssel 8" / 205 mm
Magnetschlüsselsatz 4 - 7,5 mm
Ringmaulschlüssel:
6,7,8,9,10,11,12,13,14,15,16,17,18,19,20,21,22,23,24,25,26,27,28,32 mm
Montiereten 500 mm
Flachmeißel 200 x 25 mm
Kreuzmeißel 150 x 6 mm
Durchtreiber 120 / 2 mm
Körner 120 / 4 mm
Universal-Gripzange 250 mm
Zündkerzensatz 20,8 mm
Vergaser Schraubendreher 25 x 4
Schraubendreher für Schlitzschrauben 150 x 8
Schraubendreher für Schlitzschrauben 200 x 10
Kreuzschlitzschraubendreher No. 01 / 1 / 2 "Phillips" Socket 1/2": 10,11,12,13,14,15,16,17,18,19,20,21,22,23,24,26,27,28,30,32 mm
Kurbel 1/2"
Gelenkgriff 1/2"
Griff mit Gleitstück 1/2"
Hebelumschaltknarre 1/2"
Verlängerung 1/2" 125/250 mm
Kardangeln 1/2"
Seitenschneider 160 mm
Kombinationszange 180 mm
Kunststoffhammer Ø 35 mm
6-Kant Winkelschraubendrehersatz 2-10 mm
Flachstumpf-Feile 200 mm
Rund-Feile 200 mm
Dreikant-Feile 200 mm
Kontakt-Feile 150 mm
Drahtbürste 4-reihig
Schlosserhammer 500 gr.
Fühlerlehre 13-tlg. 0.05-1.0 mm
Prof-Bandmaß 5 m
Ölspritzkanne 250 ccm
Vorhängeschloss 40 mm
Metallsäge, verstellbar
Rohr- und Wasserpumpenzange 240 mm

Empty Tool Box
Adjustable Wrench 8" / 205 mm
Ignition Wrench Set 4 - 7,5 mm
Combination Wrenches:
6,7,8,9,10,11,12,13,14,15,16,17,18,19,20,21,22,23,24,25,26,27,28,32 mm
Tyre Lever 500 mm
Flat Cold Chisel 200 x 25 mm
Cross Cut Chisel 150 x 6 mm
Drift Punch 120 / 2 mm
Centre Punch 120 / 4 mm
Universal Grip Plier 250 mm
Sparg Plug Socket 20,8 mm
Stubby Screwdriver 25 x 4
Slot Screwdriver 150 x 8
Slot Screwdriver 200 x 10
Crosst Slot Screwdriver No. 01 / 1 / 2 "Phillips" Socket 1/2": 10,11,12,13,14,15,16,17,18,19,20,21,22,23,24,26,27,28,30,32 mm
Speed Brace 1/2"
Swivel Handle 1/2"
Sliding T-Handle 1/2"
Reversible Ratchet 1/2"
Extension Bar 1/2" 125/250 mm
Universal Joint 1/2"
Diagonal Side Cutting Nipper 160 mm
Combination Plier 180 mm
Plastic Hammer Ø 35 mm
Hexagonal Head Wrench Set 2-10 mm
Engineers Hand File 200 mm
Round File 200 mm
Threesquare File 200 mm
Contact File 150 mm
Wire Brush 4-rows
Engineers Hammer 500 gr.
Feeler Gauge 13-pcs. 0.05-1.0 mm
Professional Measuring Tape 5 m
Oil Can 250 ccm
Padlock 40 mm
Adj. Hacksaw Frame
Universal Plier 240 mm

Bestell-No. Order-No.	tlg./pcs.	
01000091582	100	1

2199 98



Bestell-No. Order-No.	spez. für/spec. for HEYCO	
02199004045	1000 + 1002	1

1127-1 Werkstattwagen, leer / Workshop Trolley, empty „INTELLIGENT TOOLS“ 111 113



- Automatisches Bremsystem
- Automatischer Softeinzug der Schubladen
- Hochwertige Arbeitsplatte aus Holz
- Automatic braking system
- Automatic drawers soft close
- High-quality wooden worktop

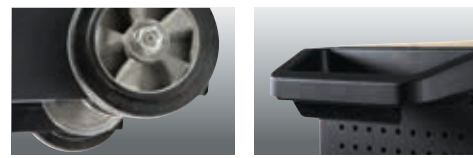

Bestell-No. Order-No.	Maße/ dimensions		
01127010020	1080 x 1050 x 610 mm	125.000	1

1127-2 Werkstattwagen, leer / Workshop Trolley, empty „PROFESSIONAL“ 111 113



- 2 Lenkrollen mit Feststellbremse
- Automatischer Softeinzug der Schubladen
- Hochwertige Arbeitsplatte aus Holz
- 2 steering rollers with parking brake
- Automatic drawers soft close
- High-quality wooden worktop

Bestell-No. Order-No.	Maße/ dimensions		
01127020020	1080 x 1050 x 610 mm	120.000	1



Die neue Werkstattwagen-Serie

The new workshop trolleys series



1127-1

Werkstattwagen „INTELLIGENT TOOLS“

- Automatisches Bremssystem
- Automatischer Softeinzug der Schubladen
- Hochwertige Arbeitsplatte aus Holz

Workshop trolley „INTELLIGENT TOOLS“

- Automatic braking system
- Automatic drawers soft close
- High-quality wooden worktop



1127-2

Werkstattwagen „PROFESSIONAL“

- 2 Lenkrollen mit Feststellbremse
- Automatischer Softeinzug der Schubladen
- Hochwertige Arbeitsplatte aus Holz

Workshop trolley „PROFESSIONAL“

- 2 steering rollers with parking brake
- Automatic drawers soft close
- High-quality wooden worktop



1127-3

Werkstattwagen „BASIC“

- 2 Lenkrollen mit Feststellbremse
- Mit ABS-Arbeitsplatte

Workshop trolley „BASIC“

- 2 steering rollers with parking brake
- With ABS worktop



HEYCO



Die Synthese aus Raum, Sicherheit und Ergonomie. Der weltweit erste Werkstattwagen mit automatischem Softeinzug und Sicherheits-Zwei-Rad-Bremssystem mit Start/Stop Automatik.

The synthesis from space, security and ergonomics. The world-wide first workshop trolley with automatic drawers soft close and security-2-wheels braking system with automatic start/stop mechanism.



Abbildung kann von der Serie abweichen - Serienänderungen vorbehalten!
Illustration can differ from series, which is subject to change without prior notice!

Abmessungen: ca. 1080 x 1050 x 610 mm aus Stahlblech
Korpus schwarz - Schubladen schwarz
Dimensions: approx. 1080 x 1050 x 610 mm from sheet steel
Body black - drawers black

Ablagefläche aus Holz. Maße: ca. 1000 x 560 x 30 mm
getrennte Verriegelungen der Front- und Seitenschubfächer durch zwei Zylinderschlösser

Working top of wood. Dimensions: approx. 1000 x 560 x 30 mm
separate locking mechanism for front- and side drawers with two cylinder locks

11 Schubladen /drawers

- 1 6 Schubladen /drawers ca./approx. 570 x 420 x 45 mm
- 2 1 Schubfach /drawer ca./approx. 570 x 420 x 105 mm
- 3 1 Schubfach /drawer ca./approx. 570 x 420 x 165 mm
- 4 1 Schubfach /drawer ca./approx. 425 x 125 x 255 mm
- 5 1 Schubfach /drawer ca./approx. 425 x 125 x 420 mm
- 6 1 Schubfach /drawer ca./approx. 470 x 360 x 50 mm

- 7 1 Ablagefach ca. 700 x 390 x 65 mm
1 additional compartment approx. 700 x 390 x 65 mm

2 Lenkrollen /2 steering rollers
2 Festrollen /2 castors

Tragfähigkeit max 600 kg
total carrying capacity max 600 kg

ca. 30 kg Belastbarkeit pro Schubfach,
Leergewicht ca. 125 kg
approx. 30 kg loading capacity for each drawer,
weight empty approx. 125 kg



- A+E** Kugelgelagerte Teleskopschienen voll ausziehbar und belastbar mit gedämpftem Softeinzug.
- B** Optimale Raumaussnutzung durch senkrecht angeordnete Schubladen für Verbrauchsmaterial und Werkzeuge. Ideal für Dosen und Flaschen.
- C** Alufelgen mit Niederquerschnittsreifen und Sicherheits-Zwei-Rad-Bremssystem. Die automatische Betätigung garantiert einen sicheren Stand auch bei unebenen Bodenverhältnissen.
- D** Griffleiste aus hochwertigem Lufffahrtaluminium.
- C+G** Stabiler Griff mit integrierter **Start/Stop** Automatik zum einfachen Lösen der Feststellbremse. Beim Loslassen des Griffes wird die Feststellbremse automatisch betätigt.
- H** Zwei separat abschließbare Staufächer, zur sicheren Aufbewahrung von hochwertigen Meß- und Prüfgeräten.

- A+E** Telescopic slides with ball bearings fully extendable, with high load capacity and damped soft close mechanism.
- B** Optimal utilization of space by vertically arranged drawers for consumables and tools. Ideal for cans and bottles.
- C** Alloy wheels with low profile tyres and safety 2-wheels braking system. The automatic operation ensure a safe stand, also on uneven ground conditions.
- D** Handle made of aeronautical aluminium.
- C+G** Stable handle with integrated **Start/Stop** automatic for easy release of the brake. When releasing the handle the brake is automatically actuated.
- H** Two separately lockable storage compartments, for safe storage of high value testing equipment.

1127-3 Werkstattwagen, leer / Workshop Trolley, empty

„BASIC“

111 113



- 2 Lenkrollen mit Feststellbremse
- Mit ABS-Arbeitsplatte
- 2 steering rollers with parking brake
- With ABS worktop

Bestell-No. Order-No.	Maße/ dimensions		
01127030020	1080 x 1050 x 610 mm	104.000	1

1128

114 115



Belastbarkeit pro Schublade: 30 kg
Loading capacity for each drawer: 30 kg

**Verbessertes Modell
Modified model**

Bestell-No. Order-No.	Maße/ dimensions	
01128010020	890 x 490 x 865 mm	1

1128-8-5 1128-8-9

117

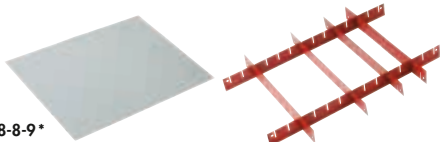

1128-8-9*
Gummimatte
Auch passend für Werkstattwagen 1127
Rubber mat
Also suitable for workshop trolley 1127

1128-8-5**
Trennleisten
Divider set

Bestell-No. Order-No.	Maße/ dimensions	für/for HEYCO No.	
01128110100*	562 x 416 x 2 mm	1128	1
01128110200**	45 mm hoch/height	1128	1

1129

115



Bestell-No. Order-No.	Maße/ dimensions	
01129010020	600 x 440 x 950 mm	1

1128/1129-8-15

116



Preis ohne Werkstattwagen
Price without workshop trolley
für Werkstattwagen HEYCO 1128/1129

Bestell-No. Order-No.	Maße/ dimensions	
01128801500	940 x 500 x 730 mm	1
01129801500	730 x 500 x 840 mm	1

1129-8-1 - 1129-8-8

für / for HEYCO No. 1129

1129-8-1
Papierkorb
Waste-paper basket



1129-8-2
Papierrollenhalter
Paper roll holder



1129-8-3
(1129-8-4)
Trennblech/Satz
Divider set for drawers



1129-8-5
Fachteiler /Satz
Slotted divider set for drawers



1129-8-6
(1129-8-7)
Ablageschale
Storage box



1129-8-8
Dosenhalter
Tin holder



1129-8-12
Papier-Satz
Set of paper basket
and holder

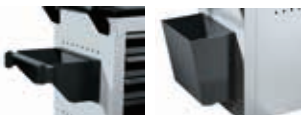

Bestell-No. Order-No.	No.	Maße/ dimensions	
91129800120	1129-8-1	300 x 250 x 300 mm	1
91129800220	1129-8-2	300 x 200 x 250 mm	1
91129800360	1129-8-3	348 x 60 mm	1
91129800460	1129-8-4	348 x 100 mm	1
91129800560	1129-8-5	348 x 100 x 60 mm	1
91129800620	1129-8-6	220 x 60 x 80 mm	1
91129800720	1129-8-7	300 x 60 x 80 mm	1
91129800820	1129-8-8	160 x 300 x 10 mm	1
91129801220	1129-8-12	1129-8-1+1129-8-2	1

1135

99



Bestell-No. Order-No.	Maße/ dimensions	
01135010020	635 x 350 x 400 mm	1

1140

99



Bestell-No. Order-No.	Maße/ dimensions	
01140010020	650 x 330 x 350 mm	1

Werkzeugsortimente in Behältnissen
Tool Assortments in receptacles

1002-910 - 1140-943

Bestell-No. Order-No.	No.	tlg./pcs.		
--------------------------	-----	-----------	--	--

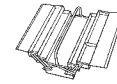

in Kästen/in tool boxes

01002910282	1002-910-M	90	89	1
01002910382	1002-910-AF	90	89	1



in Schränken/in wall cabinets

01101911282	1101-911-M	114	90/91	1
01101911382	1101-911-AF	114	90/91	1



in Werkstattwagen/in workshop trolleys

01128933282	1128-933-M	111	100/101	1
01128933382	1128-933-AF	109	100/101	1
01128942282	1128-942-M	141	102/103	1
01128942382	1128-942-AF	136	102/103	1
01128943282	1128-943-M	166	94/95	1
01128943382	1128-943-AF	157	94/95	1

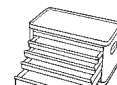

in Truhen/in tool chests

01135933282	1135-933-M	111	100/101	1
01135933382	1135-933-AF	109	100/101	1

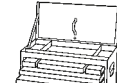

in Truhen/in tool chests

01140933282	1140-933-M	111	100/101	1
01140933382	1140-933-AF	109	100/101	1
01140942282	1140-942-M	141	102/103	1
01140942382	1140-942-AF	136	102/103	1
01140943282	1140-943-M	166	104/105	1
01140943382	1140-943-AF	157	104/105	1

E 970-3

85



Bestell-No. Order-No.	
00970000300	1

1128-8



HEYCO
formel plus

Inhalt / content



968-8



973-8



990-4



985-0010



991-8



992-4



E 970-3



E 970-3

Bestell-No. Order-No.	tlg./pcs.	Module/modules	
01128000800	58	8	1

1128-3



HEYCO
formel plus

Inhalt / content



1128-21



1128-22



1128-23

Bestell-No. Order-No.	tlg./pcs.	Module/modules	
01128000300	190	3	1

Module/modules
960-7 – 1128-23

960-7



Bestell-No. Order-No.	MM	tlg./pcs.	
00960001080	2,5 – 10	7	1

961-7



Bestell-No. Order-No.	MM	tlg./pcs.	
00961001080	T 10 – T 40	7	1

965-9



Bestell-No. Order-No.	MM	tlg./pcs.	
00965000280	6 x 7 – 20 x 22	9	1
	+ 1360		

968-8



Bestell-No. Order-No.	MM	tlg./pcs.	
00968000282	6 x 7 – 20 x 22	8	1

969-10



Bestell-No. Order-No.	MM	tlg./pcs.	
00969000282	6 x 7 – 27 x 30	10	1

970-10



Bestell-No. Order-No.	MM	tlg./pcs.	
00970000282	6 x 7 – 30 x 32	10	1

Module/modules
960-7 – 1128-23

971-17



Bestell-No. Order-No.	MM	tlg./pcs.	
00971000282	6 – 24	17	1

972-14



Bestell-No. Order-No.	MM	tlg./pcs.	
00972000283	10 – 24	14	1

973-8



Bestell-No. Order-No.	MM	tlg./pcs.	
00973000282	6 x 7 – 20 x 22	8	1

975-3010



HEYCO
VARICAT



Bestell-No. Order-No.	MM	tlg./pcs.	
00975301083		38	1

980-14



Bestell-No. Order-No.	tlg./pcs.	
00980000083	14	1

984-3800



Bestell-No. Order-No.	tlg./pcs.	
00984380036	23	1

Module/modules
960-7 – 1128-23

985-0010 985-3010 1/2



HEYCO
VARICAT



Bestell-No. Order-No.	tlg./pcs.	
00985001083	23	1
00985301083	23	1

990-4



Bestell-No. Order-No.	tlg./pcs.	
00990001086	4	1

990-4-1 VDE



Bestell-No. Order-No.	tlg./pcs.	
00990002088	4	1

991-7



Bestell-No. Order-No.	tlg./pcs.	
00991001580	7	1

991-8



Bestell-No. Order-No.	tlg./pcs.	
00991001080	8	1

991-8-1 VDE



Bestell-No. Order-No.	tlg./pcs.	
00991002033	8	1

Module/modules
960-7 – 1128-23

992-4



Bestell-No. Order-No.	tlg./pcs.	
00992000087	4	1

995-8



Bestell-No. Order-No.	tlg./pcs.	
00995000021	8	1

1128-21



Bestell-No. Order-No.	tlg./pcs.	
01128812100	55	1

1128-22



Bestell-No. Order-No.	tlg./pcs.	
01128812200	110	1

1128-23



Bestell-No. Order-No.	tlg./pcs.	
01128812300	25	1

1090



Aus Nylon und selbsthaftendem Non-slip-Material
Schwarz mit grüner Einfassung

- Haftet auf allen Materialien und Untergründen
- Unbedenklich für alle Lacke
- Ölabweisend
- Voll waschbar
- Schützt zuverlässig vor Beschädigungen

Auch für moderne Karosserien aus Aluminium und Kunststoff geeignet

Made from high-strength nylon and self-adhesive non-slip material
Black, with green bordering

- Adheres to all materials and backings
- Convenient for all paints
- Repellent to oil
- Fully washable
- Reliable protection against damages

Also suitable for modern car bodies from aluminium and synthetic materials

Bestell-No. Order-No.	Maße/ dimensions		
01090000000	880 x 500 mm	315	1

1090-1 Kniebrett /
Kneeling Mat

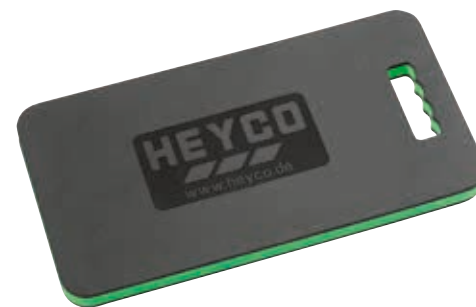

- Feuchtigkeits- und schmutzabweisend
- Mit integriertem Tragegriff
- Resistent gegen: Öl, Benzin und Chemikalien
- Individuell einsetzbar
- Kleidung, sowie Knie bleiben sauber und trocken

- Repellent to moisture and dirt
- With integrated carrying handle
- Resistant against: oil, petrol and chemicals
- Multiple use
- Clothing and knees remain clean and dry

Bestell-No. Order-No.	Maße/ dimensions		
01090000100	480 x 250 x 30 mm	130	1

1170



System
„Tegometall“

Bestell-No. Order-No.	tlg./pcs.	
01170010020	40	1

1171



System
„Tegometall“

Bestell-No. Order-No.	tlg./pcs.	
01171010020	18	1

1172



System
„Tegometall“

Bestell-No. Order-No.	tlg./pcs.	
01172010020	8	1

1174



Bestell-No. Order-No.	tlg./pcs.	
01174010020	1	1

1186



HEYCO
VARICAT

Bestell-No. Order-No.	Maße/ dimensions	tlg./pcs.	
01186001083	355 x 280 x 420 mm	26	1
10 Stck.	25-00-10 $\frac{1}{4}$		
9 Stck.	40-00-10 $\frac{3}{8}$		
7 Stck.	50-00-10 $\frac{1}{2}$		

1187



taLenta®

Bestell-No. Order-No.	Maße/ dimensions	tlg./pcs.	
01187541083	205 x 205 x 350 mm	12	1
12 Stck.	50-40-10 $\frac{1}{2}$		

Zubehör zu/Accessories for
HEYCO 1170, 1171, 1172, 1174

1170-8-1 1170-8-2



Bestell-No. Order-No.	No.	Maße/ dimensions	
01170800120	1170-8-1	1000 x 260 mm	1
01170800220	1170-8-2	455 x 260 mm	2

1170-11 1174-11



Bestell-No. Order-No.	No.	Maße/ dimensions	
01170110020	1170-11	1000 x 180 x 470 mm	1
01174110020	1174-11	665 x 180 x 470 mm	1

1171-8-1



Bestell-No. Order-No.	Maße/ dimensions	
01171800120	320 x 260 mm	2

1172-8-1



Bestell-No. Order-No.	Maße/ dimensions	
01172800120	760 x 260 mm	1

Standard-Hakensortimente
Standard Hook-Assortments

1176-1 - 1176-3



Bestell-No. Order-No.	No.	tlg./pcs.	
01176000160	1176-1	115	1
01176000260	1176-2	175	1
01176000360	1176-3	180	1

1177-1-1 - 1177-2-4



Bestell-No. Order-No.	No.	←L→ mm	∅ mm	
01177100160	1177-1-1	50	4,8	10
01177100260	1177-1-2	120	4,8	10
01177100360	1177-1-3	200	4,8	10
01177200360	1177-2-3	200	5,9	10
01177200460	1177-2-4	250	5,9	10

1177-1-5



Bestell-No. Order-No.	Maße/ dimensions	für/for	∅ mm	
01177100500	27 x 42 mm		4,8	10

1178-1-2 - 1178-1-4



Bestell-No. Order-No.	No.	←L→ mm	∅ mm	
01178100260	1178-1-2	120	4,8	10
01178100360	1178-1-3	200	4,8	10
01178100460	1178-1-4	300	4,8	10

1178-1-5



Bestell-No. Order-No.	Maße/ dimensions	für/for	∅ mm	
01178100500	27 x 42 mm		4,8	10

1179-1-1



Bestell-No. Order-No.	←L→ mm	∅ mm	
01179100160	40	4,8	20

1179-1-2



Bestell-No. Order-No.	←L→ mm	∅ mm	
01179100260	130	4,8	20

300 DIN · ISO 8976



C/CP



CPI



Bestell-No. Order-No.	Ausf./finish	←L→ mm	"	
00300020080	C	200	8	1
00300020082	CP	200	8	1
00300024082	CP	240	9,1/2	1
00300020086	CPI	200	8	1
00300024086	CPI	240	9,1/2	1

313



Bestell-No. Order-No.	←L→ mm	"	
00313017521	175	7	1
00313024021	240	9,1/2	1

315



CP



CPI



Bestell-No. Order-No.	Ausf./finish	←L→ mm	"	
00315024082	CP	240	9,1/2	1
00315024086	CPI	240	9,1/2	1

1200 DIN · ISO 5746



CPD



CPI



Bestell-No. Order-No.	Ausf./finish	←L→ mm	"		∅ mm	
01200016087	CPD	160	6,1/4	1,8	1	
01200018087	CPD	180	7	2,5	1	
01200020087	CPD	200	8	2,5	1	
01200016086	CPI	160	6,1/4	1,8	1	
01200018086	CPI	180	7	2,5	1	
01200020086	CPI	200	8	2,5	1	

1206 DIN · ISO 5745



CPD



CPI



Bestell-No. Order-No.	Ausf./finish	←L→ mm	"	
01206016087	CPD	160	6,1/4	1
01206016086	CPI	160	6,1/4	1

1207 DIN · ISO 5745



CPD



CPI



Bestell-No. Order-No.	Ausf./finish	←L→ mm	"	
01207016087	CPD	160	6,1/4	1
01207016086	CPI	160	6,1/4	1

1208 DIN · ISO 5745



CPD



CPI



Bestell-No. Order-No.	Ausf./finish	←L→ mm	"		∅ mm	
01208014087	CPD	140	5,1/2	1,6	1	
01208016087	CPD	160	6,1/4	1,6	1	
01208020087	CPD	200	8	1,8	1	
01208014086	CPI	140	5,1/2	1,6	1	
01208016086	CPI	160	6,1/4	1,6	1	
01208020086	CPI	200	8	1,8	1	

1209 DIN · ISO 5745



CPD



CPI



Bestell-No. Order-No.	Ausf./finish	←L→ mm	"		∅ mm	
01209020087	CPD	200	8	1,8	1	
01209020086	CPI	200	8	1,8	1	

1212 DIN · ISO 5749



CPD



CPI



Bestell-No. Order-No.	Ausf./ finish	←L→ mm	↔ "	⊕ mm	⊖ mm	
01212014087	CPD	140	5.1/2	1,8		1
01212016087	CPD	160	6.1/4	2,0		1
01212020087	CPD	200	8	2,5		1
01212014086	CPI	140	5.1/2	1,8		1
01212016086	CPI	160	6.1/4	2,0		1
01212020086	CPI	200	8	2,5		1

1213 DIN · ISO 5749



CPD



CPI



Bestell-No. Order-No.	Ausf./ finish	←L→ mm	↔ "	⊕ mm	⊖ mm	
01213012587	CPD	125	5	1,5		1
01213014087	CPD	140	5.1/2	1,8		1
01213016087	CPD	160	6.1/4	2,0		1
01213012586	CPI	125	5	1,5		1
01213014086	CPI	140	5.1/2	1,8		1
01213016086	CPI	160	6.1/4	2,0		1

1215 DIN · ISO 5748



CPD



CPI



Bestell-No. Order-No.	Ausf./ finish	←L→ mm	↔ "	⊕ mm	⊖ mm	
01215016087	CPD	160	6.1/4	2,2		1
01215016086	CPI	160	6.1/4	2,2		1

1220



Bestell-No. Order-No.	←L→ mm	↔ "	⊕ mm	⊖ mm	
01220016086	160	6.1/4	1,1-4,8		1

Sicherheitswerkzeuge / Insulated Safety Tools = *



IEC 900/DIN EN 60900/VDE 0682 Teil/part 201

1200 VDE * DIN · ISO 5746



Bestell-No. Order-No.	←L→ mm	↔ "	⊕ mm	⊖ mm	
01200016088	160	6.1/4	1,8		1
01200018088	180	7	2,5		1
01200020088	200	8	2,5		1

1206 VDE * DIN · ISO 5745



Bestell-No. Order-No.	mm	←L→ "	
01206016088	160	6,1/4	1

1207 VDE * DIN 5745



Bestell-No. Order-No.	mm	←L→ "	
01207016088	160	6,1/4	1

1208 VDE * DIN 5745



Bestell-No. Order-No.	mm	←L→ "	⊕ mm	⊖ mm	
01208016088	160	6.1/4	1,6		1
01208020088	200	8	1,8		1

1209 VDE * DIN 5745



Bestell-No. Order-No.	←L→ mm	↔ "	⊕ mm	⊖ mm	
01209020088	200	8	1,8		1

1213 VDE * DIN · ISO 5749



Bestell-No. Order-No.	←L→ mm	↔ "	⊕ mm	⊖ mm	
01213014088	140	5.1/2	1,8		1
01213016088	160	6.1/4	2,0		1
01213018088	180	7	2,5		1

1220 VDE *



Bestell-No. Order-No.	←L→ mm	↔ "	⊕ mm	⊖ mm	
01220016088	160	6.1/4	1,1-4,8		1

49-5 VDE *



Bestell-No. Order-No.	tlg./pcs.	
00049000500	9	1

1052 VDE



Bestell-No. Order-No.	tlg./pcs.	
01052001000	14	1
01052000000	leer / empty	1

1230



Bestell-No. Order-No.	←L→ mm	↔ "	
01230021550	215	8.1/2	1

1231



Bestell-No. Order-No.	←L→ mm	↔ "	
01231034055	340	13.1/4	1

1232 Spannzange für Achsmanschetten und Schlauchklemmen / Tongs for axle collars and hose clamps

142



max. 30 Nm Anzugsdrehmoment
Drehmomentschlüssel vorgeschrieben (sonst Bruch)

max. 30 Nm tightening torque
Torque Wrench mandatory (otherwise breakage)

- Zum Verklammern von Spannbändern für Achsmanschetten und Schläuche
- Passend für Stahl und Edelstahlklemmen
- Gewichtsoptimiert durch hochfestes Luftfahrtaluminium
- Gehärtete Spannbacken
- Einfaches Einstellen des vorgeschriebenen Drehmoments über den 3/8" - Antrieb mit Hilfe eines Drehmomentschlüssels
- Griff aus leicht abwaschbarem Kunststoff
- Max. Öffnungsweite: 45 mm
- For clamping of fastener straps of axle collars and hoses
- Suitable for steel- and stainless steel-clamps
- Optimized weight through high-tensile aircraft aluminium
- Hardened clamping jaws
- Simple setting of the required torque through the 3/8" - drive by means of torque wrench
- Handle made of easily washable plastic
- Max. opening width: 45 mm

Bestell-No. Order-No.	mm	"	
01232027500	280	11	1

1233 Auswuchtgewichtzange / Balancing Weight Pliers

142



Chrom-Vanadium
C = verchromt

Chrome-Vanadium
C = chromium plated

- Zum Befestigen, Lösen, Verschieben und Zuschneiden von Auswuchtgewichten
- Zum Anpassen der Haltefedern
- For fixing, loosening, shifting and cutting of balancing weights
- For adjusting the clamping springs

Bestell-No. Order-No.	mm	"	
01233025080	260	10.1/4	1

1250 DIN 5254 A

143



ASD



CPD

Bestell-No. Order-No.	Ausf./ finish	dimens. Größe	für/for mm	
01250114013	ASD	A 3	3 - 10	1
01250214013	ASD	A10	10 - 25	1
01250017513	ASD	A19	19 - 60	1
01250022013	ASD	A40	40 - 100	1
01250030013	ASD	A85	85 - 140	1
01250214087	CPD	A10	10 - 25	1
01250017587	CPD	A19	19 - 60	1
01250022087	CPD	A40	40 - 100	1
01250030087	CPD	A85	85 - 140	1

1252 DIN 5254 B

143

ASD



CPD



Bestell-No. Order-No.	Ausf./ finish	dimens. Größe	für/for mm	
01252113013	ASD	B 3	3 - 10	1
01252213013	ASD	B10	10 - 25	1
01252016513	ASD	B19	19 - 60	1
01252020513	ASD	B40	40 - 100	1
01252027513	ASD	B85	85 - 140	1
01252213087	CPD	B10	10 - 25	1
01252016587	CPD	B19	19 - 60	1
01252020587	CPD	B40	40 - 100	1
01252027587	CPD	B85	85 - 140	1

1255 DIN 5256 C

143

ASD



CPD



Bestell-No. Order-No.	Ausf./ finish	dimens. Größe	für/for mm	
01255114513	ASD	C 8	8 - 13	1
01255214513	ASD	C12	12 - 25	1
01255018013	ASD	C19	19 - 60	1
01255023013	ASD	C40	40 - 100	1
01255031013	ASD	C85	85 - 140	1
01255214587	CPD	C12	12 - 25	1
01255018087	CPD	C19	19 - 60	1
01255023087	CPD	C40	40 - 100	1
01255031087	CPD	C85	85 - 140	1

1256 DIN 5256 D

144

ASD



CPD



Bestell-No. Order-No.	Ausf./ finish	dimens. Größe	für/for mm	
01256113513	ASD	D 8	8 - 13	1
01256213513	ASD	D12	12 - 25	1
01256017013	ASD	D19	19 - 60	1
01256021513	ASD	D40	40 - 100	1
01256029013	ASD	D85	85 - 140	1
01256213587	CPD	D12	12 - 25	1
01256017087	CPD	D19	19 - 60	1
01256021587	CPD	D40	40 - 100	1
01256029087	CPD	D85	85 - 140	1

1257

144



Bestell-No. Order-No.	mm	"	
01257017580	175	7	1

1258 Drahtwirbelzange mit Ratschenfunktion / Wire Swivelling Pliers with ratchet function

1258-15

1258-22



- Zum Verwirbeln und Schneiden von Sicherungsdrähten
- Gleichmäßige Verwirbelung durch Ratschenfunktion
- Rechts- und Linksdrehung ermöglicht die Öffnung von verwirbelten Drähten ohne mechanische Beschädigung des Sicherungsdrahtes
- Automatische Rückführung
- Spezial gehärtete Backen, auch für dünne Edelstahldrähte geeignet
- For swivelling and cutting of locking wires
- Consistent swivelling through ratchet function
- Clockwise and counterclockwise rotation allows opening of swivelled wires without damaging the locking wire
- Automatic feedback
- Special hardened jaws also suitable for stainless steel

Bestell-No. Order-No.	mm	"	
01258015000	150	6	1
01258022500	225	9	1

1261-1 Gewindenietzangensatz in Metallkasten / Hand Rivet Nut Tool Kit in metal case

144



Bestell-No. Order-No.	mm	"	
01261000100	250	10	1

1261 Gewindenietzange, handbetätigt / Hand Rivet Nut Tool

144



ST = standardmäßig

ST = standard

- Gehäuse aus Aludruckguß und stahlgeschmiedeten Betätigungshebel
- 4 austauschbare Mundstücke (M3, M4, M5, M6)
- Selbstöffnend durch integrierte Feder
- Stufenlos verstellbarer Anschlag
- Ergonomischer Softgriff
- Housing made of aluminium and die cast - steel forged actuating lever
- 4 exchangeable nosepieces (M3, M4, M5, M6)
- Continuously adjustable
- Ergonomic soft grip

Bestell-No. Order-No.	mm	"	
01261025000	250	10	1

1261-10 Gewindenietensatz in Kunststoffbox / Rivet Nut Set in plastic box 145



Bestehend aus vier verschiedenen Gewindenieten. Consisting of four different rivet nuts.
Gewindenieten aus Alu-Legierung. Rivet nuts made of aluminium alloy.

Bestell-No. Order-No.			
01261001000	M3 x 0,5	50 Stk./pcs	1
	M4 x 0,7	60 Stk./pcs	
	M5 x 0,8	60 Stk./pcs	
	M6 x 1,0	30 Stk./pcs	

1261-30 - 1261-60 Gewindenietensatz in Blisterverpackung / Rivet Nut Set in blister packing 145



Verpackungseinheit: 20 Stück
Gewindenieten aus Alu-Legierung.
Packing unit: 20 pcs.
Rivet nuts made of aluminium alloy.

Bestell-No. Order-No.	Maße dimensions	
01261300000	M3 x 0,5	1
01261400000	M4 x 0,7	1
01261500000	M5 x 0,8	1
01261600000	M6 x 1,0	1

1261-31 - 1261-61 Gewindedorn / Threaded Mandrel 145



Verpackungseinheit: 1 Stück
Packing unit: 1 pc.

Bestell-No. Order-No.	Maße dimensions	
01261310000	M3 x 0,5	1
01261410000	M4 x 0,7	1
01261510000	M5 x 0,8	1
01261610000	M6 x 1,0	1

1261-32 - 1261-62 Gewindenietensatz in Karton / Rivet Nut Set in carton box 145



Verpackungseinheit: 500 Stück
Gewindenieten aus Alu-Legierung.
Packing unit: 500 pcs.
Rivet nuts made of aluminium alloy.

Bestell-No. Order-No.	Maße dimensions	
01261300200	M3 x 0,5	1
01261400200	M4 x 0,7	1
01261500200	M5 x 0,8	1
01261600200	M6 x 1,0	1

1262-1 Blindnietzangensatz in Metallkasten / Blind Rivet Tool Set in metal case 145



Bestell-No. Order-No.	mm	"	
01262000100	250	10	1

1262 Blindnietzange, handbetätigt / Blind Rivet Tool, hand-operated 146



ST = standardmäßig

ST = standard

- Gehäuse aus Aludruckguß und stahlgeschmiedeten Betätigungshebel
- 4 austauschbare Mundstücke (2,4; 3,2; 4,0; 4,8 mm • 3/32"; 1/8"; 5/32"; 3/16")
- Haltefunktion der Blindniete über integrierte Federschließung
- Kunststoffschlagkappe zum Positionieren/Fixieren der Niete
- Ergonomischer Softgriff
- Housing made of aluminium and die cast - steel forged actuating lever
- 4 exchangeable nosepieces (2,4; 3,2; 4,0; 4,8 mm • 3/32"; 1/8"; 5/32"; 3/16")
- Retaining function of the blind rivet through spring closure
- Plastic stroke cap for positioning/fixation of the rivet
- Ergonomic soft grip

Bestell-No. Order-No.	mm	"	
01262025000	250	10	1

1262-10 Blindnietensatz in Kunststoffbox / Blind Rivet Set in plastic box 146



Bestehend aus vier verschiedenen Blindnieten. Consisting of four different blind rivets.
Blindnieten aus Alu-Legierung. Blind rivets made of aluminium alloy.

Bestell-No. Order-No.			
01262001000	ø 2,4 x L 5,8 mm	50 Stk./pcs	1
	ø 3,2 x L 8,0 mm	60 Stk./pcs	
	ø 4,0 x L 8,0 mm	60 Stk./pcs	
	ø 4,8 x L 8,0 mm	30 Stk./pcs	

1262-24-1 - 1262-48-1 Blindnietensatz in Blisterverpackung / Blind Rivet Set in blister packing 146



Verpackungseinheit: 30 Stück
Blindnieten aus Alu-Legierung.

Packing unit: 30 pcs.
Blind rivets made of aluminium alloy.

Bestell-No. Order-No.	Maße dimensions	
01262240100	2,4	1
01262320100	3,2	1
01262400100	4,0	1
01262480100	4,8	1

1262-24-2 - 1262-48-2 Blindnietensatz in Karton / Blind Rivet Set in carton box 146



Verpackungseinheit: 500 Stück
Blindnieten aus Alu-Legierung.

Packing unit: 500 pcs.
Blind rivets made of aluminium alloy.

Bestell-No. Order-No.	Maße dimensions	
01262240200	2,4	1
01262320200	3,2	1
01262400200	4,0	1
01262480200	4,8	1

1280-N 147



N = vernickelt
N = nickelplated

Bestell-No. Order-No.	mm	"		
01280017550	175	7	35	1
01280025050	250	10	50	1
01280030050	300	12	65	1

1280-L 147





L = lackiert
L = lacquered

Bestell-No. Order-No.	mm	"		
01280017520	175	7	35	1
01280025020	250	10	50	1
01280030020	300	12	65	1



1281



Bestell-No. Order-No.	mm	"		
01281017550	175	7	45	1
01281025050	250	10	50	1

1282



Bestell-No. Order-No.	mm	"		
01282025050	250	10	40	1

1285



Bestell-No. Order-No.	mm	"		
01285028050	280	11	55	1

1286

L = lackiert
L = lacquered



Bestell-No. Order-No.	mm	"		
01286023520	235	10	0-60	1

1286-ST



L = lackiert
L = lacquered

Bestell-No. Order-No.	mm	
01286113520	140	1

1286-4 Mobiles Grip System / Mobile Grip System



bestehend aus/containing

2 x 1286 / 2 x 1286-ST



Bestell-No. Order-No.	mm	"		
01286000420	235	10	0-60	1

2 Gripzangen mit Klemmvorrichtung in praktischer Tragetasche
2 Locking pliers with clamps in plastic carrier bag

1287



Bestell-No. Order-No.	mm		
01287009220	92	12	1

1287-24



Inhalt/contents

24 Stck./pcs.

Bestell-No. Order-No.	mm		
01287002420	92	12	1

1327-1 1327-2

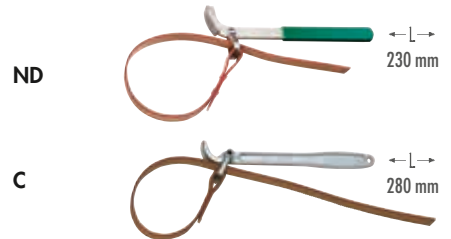

Bestell-No. Order-No.	No.	Ausf./ finish	für/for mm	für/for Ø bis/to "	
01327023054	1327-1	ND	160	6.1/4	1
01327028080	1327-2	C	240	9.1/2	1

Ersatzbänder/Spare Straps
für/for HEYCO 1327

1328

Bestell-No. Order-No.	No.	für/for	
01328100000	1328-1	1327-1	10
01328200000	1328-2	1327-2	10

1329-3 1329-4



Bestell-No. Order-No.	No.	für/for mm	für/for Ø "	
01329000354	1329-3	60 - 80	2.3/8 - 3.1/8	1
01329000454	1329-4	80 - 110	3.1/8 - 4.1/4	1

1330



Bestell-No. Order-No.	mm	für/for Ø "	
01330001020	315	1	1
01330001520	420	1.1/2	1
01330002020	535	2	1
01330003020	705	3	1

1333

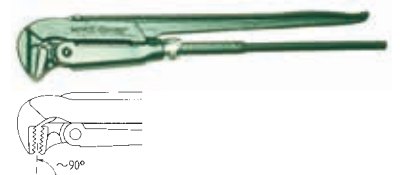

Bestell-No. Order-No.	mm	für/for Ø "	
01333001020	315	1	1
01333001520	420	1.1/2	1
01333002020	535	2	1
01333003020	685	3	1

1335

154

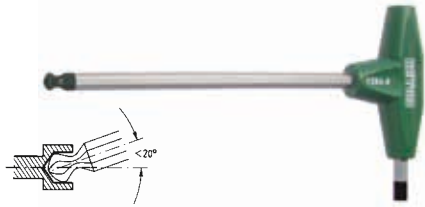

Bestell-No. Order-No.	MM	
01335002580	2,5	10
01335003080	3,0	10
01335004080	4,0	10
01335005080	5,0	10
01335006080	6,0	10
01335008080	8,0	10
01335010080	10,0	10

R 1335-6

154



in Kunststofftasche / in plastic wallets

Bestell-No. Order-No.	MM	tlg./pcs.	
01335727280	2,5 3 4 5 6 8	6	1

1337

154



Bestell-No. Order-No.	MM	
01337002580	2,5	10
01337003080	3,0	10
01337003580	3,5	10
01337004080	4,0	10
01337004580	4,5	10
01337005080	5,0	10
01337006080	6,0	10
01337007080	7,0	10
01337008080	8,0	10
01337010080	10,0	10

R 1337-6

155



in Kunststofftasche / in plastic wallets

Bestell-No. Order-No.	MM	tlg./pcs.	
01337722080	2,5 - 8	6	1

1340

DIN · ISO 2936

155



Bestell-No. Order-No.	MM	
01340001030	1	10
01340001530	1,5	10
01340002030	2	10
01340002530	2,5	10
01340003030	3	10
01340003530	3,5	10
01340004030	4	10
01340004530	4,5	10
01340005030	5	10
01340006030	6	10
01340007030	7	10
01340008030	8	10
01340009030	9	10
01340010030	10	10
01340012030	12	10
01340013030	13	10
01340014030	14	5
01340017030	17	5
01340019030	19	5
01340022030	22	5
01340024030	24	1
01340027030	27	1
01340030030	30	1
01340032030	32	1
01340036030	36	1

Bestell-No. Order-No.	AF	
01340630130	3/64	10
01340630230	1/16	10
01340630330	5/64	10
01340630430	3/32	10
01340630530	1/8	10
01340630730	5/32	10
01340630830	3/16	10
01340631030	7/32	10
01340631230	1/4	10
01340631430	9/32	10
01340631630	5/16	10
01340631930	3/8	10
01340632130	7/16	10
01340632330	1/2	10
01340632530	9/16	5
01340632730	5/8	5
01340633130	3/4	5

H 1340

156



Bestell-No. Order-No.	No.	MM	tlg./pcs.	
01340622030	H 1340-6-M	2,5 - 8	6	5
01340623030	H 1340-7-M	2,5 - 10	7	5

Bestell-No. Order-No.	No.	AF	tlg./pcs.	
01340637030	H 1340-5-AF	5/32 - 5/16	5	5
01340638030	H 1340-6-AF	5/64 - 7/32	6	5

HP 1340-9

156



Bestell-No. Order-No.	MM	tlg./pcs.	
01340825030	1,5 - 10	9	1

K 1340

156



Bestell-No. Order-No.	No.	MM	tlg./pcs.	
01340524030	K 1340-8-M	2 - 10	8	1

Bestell-No. Order-No.	No.	AF	tlg./pcs.	
01340534030	K 1340-8-AF	1/16 - 1/4	8	1

R 1340

156



in Kunststofftasche / in plastic wallets

Bestell-No. Order-No.	No.	MM	tlg./pcs.	
01340725530	R 1340-10-M	2 - 10	10	1
01340727030	R 1340-12-M	2 - 12	12	1

Bestell-No. Order-No.	No.	AF	tlg./pcs.	
01340735530	R 1340-10-AF	1/16 - 3/8	10	1
01340737030	R 1340-12-AF	1/16 - 1/2	12	1

1341 DIN · ISO 2936



Bestell-No. Order-No.	MM	
01341002030	2	10
01341002530	2,5	10
01341003030	3	10
01341004030	4	10
01341005030	5	10
01341006030	6	10
01341007030	7	10
01341008030	8	10
01341009030	9	10
01341010030	10	10
01341012030	12	10
01341014030	14	5
01341017030	17	5
01341019030	19	5

R 1345-7



in Kunststofftasche / in plastic wallets

Bestell-No. Order-No.	für Schrauben for screws	tlg./pcs.	
01345723030	M 5 - M 16	7	1

1348 (TORX®)



Bestell-No. Order-No.	Größe size	
01348000630	T 6	10
01348000730	T 7	10
01348000830	T 8	10
01348000930	T 9	10
01348001030	T 10	10
01348001530	T 15	10
01348002030	T 20	10
01348002530	T 25	10
01348002730	T 27	10
01348003030	T 30	10
01348004030	T 40	10
01348004530	T 45	10
01348005030	T 50	10
01348005530	T 55	10
01348006030	T 60	10

HP 1343-9

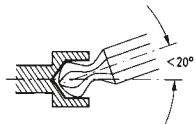

Bestell-No. Order-No.	MM	tlg./pcs.	
01343825030	1,5 - 10	9	1

1347 (TORX®)



Bestell-No. Order-No.	Größe size	
01347000680	T 6	10
01347000780	T 7	10
01347000880	T 8	10
01347000980	T 9	10
01347001080	T 10	10
01347001580	T 15	10
01347002080	T 20	10
01347002580	T 25	10
01347002780	T 27	10
01347003080	T 30	10
01347004080	T 40	10
01347004580	T 45	10

H 1348-8



Bestell-No. Order-No.	Größe size	tlg./pcs.	
01348624030	T 9 - T 40	8	5

1345 (XZN)





Bestell-No. Order-No.	für Schrauben for screws	
01345000530	M 5	10
01345000630	M 6	10
01345000830	M 8	10
01345001030	M 10	10
01345001230	M 12	10
01345001430	M 14	5
01345001630	M 16	5

R 1347-6



in Kunststofftasche / in plastic wallets

Bestell-No. Order-No.		tlg./pcs.	
01347722080	T10 T15 T20 T25 T30 T40	6	1

R 1348-10



in Kunststofftasche / in plastic wallets

Bestell-No. Order-No.	Größe size	tlg./pcs.	
01348725530	T 8 - T 50	10	1

HP 1349-8 (TORX®)

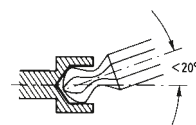



Bestell-No. Order-No.	Größe size	tlg./pcs.	
01349824030	T 9 - T 40	8	1

1405

 160



Bestell-No. Order-No.	No.	 mm	
01405001080	1	80	10
01405002080	2	100	10
01405003080	3	150	10
01405004080	4	200	10

1411 DIN · ISO 8764-2

 160



No. 01 + 02





No. 0 + 1 + 2



No. 3 + 4

mit schlagfestem Kunststoffheft
Shockproof plastic handle

Bestell-No. Order-No.	No.	 mm	 mm	
01411000180	01	-	25	10
01411000280	02	-	25	10
01411000080	0	-	60	10
01411001080	1	-	80	10
01411002080	2	-	100	10
01411003080	3	13	150	10
01411004080	4	17	200	5

1412

 160





No. 01 + 02



No. 0 + 1 + 2



No. 3 + 4

Bestell-No. Order-No.	No.	 mm	 mm	
01412000180	01	-	25	10
01412000280	02	-	25	10
01412000080	0	-	60	10
01412001080	1	-	80	10
01412002080	2	-	100	10
01412003080	3	13	150	10
01412004080	4	17	200	5

1415

 161



Bestell-No. Order-No.	Größe size	
01415000680	T 6	10
01415000780	T 7	10
01415000880	T 8	10
01415000980	T 9	10
01415001080	T 10	10
01415001580	T 15	10
01415002080	T 20	10
01415002580	T 25	10
01415002780	T 27	10
01415003080	T 30	10
01415004080	T 40	10
01415004580	T 45	10

1417

 161







Bestell-No. Order-No.	Klinge blade	
01417011050	6,0 mm	10

1430

DIN 5625 / ISO 2380-2

 161







Bestell-No. Order-No.	 mm	 mm	 mm	
01430010080	1,0	5,5	100	10
01430012580	1,2	6,5	125	10
01430015080	1,2	8	150	10
01430020080	1,6	10	200	5
01430025080	2,0	12	250	5
01430030080	2,5	14	300	5

1435

 161







Bestell-No. Order-No.	 mm	 mm	 mm	
01435006080	0,4	2,5	60	10
01435007580	0,5	3	75	10
01435010080	0,5	3	100	10
01435012580	0,8	4	125	10
01435015080	0,8	5	150	10
01435017580	0,8	5	175	10
01435020080	0,8	5	200	10

1436

 162







Bestell-No. Order-No.	 mm	 mm	 mm	
01436006085	0,4	2,5	60	10
01436007585	0,5	3	75	10
01436010085	0,5	3,5	100	10
01436012585	0,8	4	125	10
01436015085	0,8	5	150	10
01436017585	0,8	5	175	10
01436020085	0,8	5	200	10

1437

DIN 5265 D / ISO 2380-2

 162







Bestell-No. Order-No.	 mm	 mm	 mm	 mm	
01437010080	1,0	5,5	100	8	10
01437012580	1,2	6,5	125	10	10
01437015080	1,2	8	150	13	10
01437017580	1,6	10	175	13	10
01437020080	2,0	12	200	16	5
01437025080	2,5	14	250	16	5

1445

 162







Bestell-No. Order-No.	 mm	 mm	 mm	
01445004080	0,8	4	25	10
01445006080	1,2	6,5	25	10

1470

 162



Bestell-No. Order-No.	 mm	 mm	 mm	 mm	
01470007580	0,6	3,5	75	6	10
01470009080	0,8	4,5	90	6	10
01470010080	1,0	5,5	100	8	10
01470012580	1,2	7	125	10	10
01470015080	1,2	8	150	12	10
01470017580	1,6	10	175	12	10
01470020080	2,0	12	200	13	5
01470025080	2,5	14	250	16	5

49-8

 163





Bestell-No. Order-No.	tlg./pcs.	
00049000880	16	1

1452 1454

 163



1454

Bestell-No. Order-No.	No.	tlg./pcs.	
01452000080	1452	 7	1
01454000080	1454	 7	1

1456 1458



1456

Bestell-No. Order-No.	No.	tlg./pcs.		
01456000080	1456	7	1	
01458000080	1458	7	1	

1460



Bestell-No. Order-No.	tlg./pcs.	
01460000080	8	1

Sicherheitswerkzeuge / Insulated Safety Tools



1000 Volt/volt = *
EN 60900

1411 VDE *
DIN 7438



Bestell-No. Order-No.	No.		
01411000033	0	60	10
01411001033	1	80	10
01411002033	2	100	10
01411003033	3	150	10

1436 VDE *
DIN 7437



Bestell-No. Order-No.				
01436007533	0,4	2,5	75	10
01436010033	0,5	3,5	100	10
01436010133	0,8	4,0	100	10
01436012533	1,0	5,5	125	10
01436015033	1,2	6,5	150	10
01436017533	1,2	8,0	175	10

1450 VDE *



Bestell-No. Order-No.	tlg./pcs.	
01450000033	7	1

49-5 VDE *



Bestell-No. Order-No.	tlg./pcs.	
00049000050	9	1

1419



Bestell-No. Order-No.	Volt/volt	
01419000045	6 - 24	10

1420



Bestell-No. Order-No.	Volt/volt				
01420000050	6 - 24	0,7	3	44	10

1424



Bestell-No. Order-No.	Volt/volt				
01424000050	220 - 250	0,5	3	65	10

1425



Bestell-No. Order-No.	Volt/volt				
01425000050	220 - 250	0,5	3,5	100	10

1426 VDE



Bestell-No. Order-No.	Volt/volt	
01426000000	12 - 750	1

1427 VDE



Bestell-No. Order-No.	Volt/volt				
01427000000	150 - 250	0,6	3	65	10

1479



Bestell-No. Order-No.	No.		
01479000080	2	6	10

1480 Universal-Schalterschrank-schlüssel / Universal control cabinet key



Durch einen doppelten Drehmechanismus können vier verschiedene Schließungen in Position gebracht werden. Universell einsetzbar für fast alle gängigen Schließsysteme in der:

- Elektrotechnik
 - Gas- und Wasserversorgung
 - Heizung-, Klima- und Sanitärbereich.
- Eine 1/4" Bitaufnahme ermöglicht den Einsatz aller handelsüblichen Bits. Ein Neodym Dauermagnet hält den Bit sicher in der Aufnahme.

For different locking positions can be selected by a double rotary-mechanism. All-purpose device for prevalent locking systems in the field of

- Electro-technics
- Gas and water supply
- Heating, air conditioning and sanitary installations

The 1/4" bit adaptor allows the utilisation of all standard bits. A Neodym permanent magnet securely keeps the bit in its position.

Bestell-No. Order-No.	für/for	
0148000060	1/4"	1

1483 DIN 5200



Bestell-No. Order-No.	mm	mm	
01483010050	0,8	4	10
01483012550	1,0	5,5	10
01483015050	1,2	8	10
01483017550	1,6	10	10
01483020050	2,0	12	10

1484 DIN 5208



Bestell-No. Order-No.	No.	
01484010250	1 + 2	10
01484030450	3 + 4	10

1491



Bestell-No. Order-No.	für Schrauben for screws M	tlg./pcs.	
01491000500	3 - 18 1/8 - 3/4	5	1
01491000600	3 - 24 1/8 - 1	6	1
01491000800	3 - 45 1/8 - 1.3/4	8	1

1494



Bestell-No. Order-No.	No.	Magnet mm	Zugkraft g/ Lifting capacity g	
01494000183	1494-1	6	500	5
01494000283	1494-2	12	1800	5
01494000383	1494-3	16	3000	5

1495-3



Bestell-No. Order-No.	mm	Greif-/gripping max. mm	
01495000380	650	7	1

1496-2 1497



Bestell-No. Order-No.	No.	Spiegelmaße dimensions of mirror	mm	
01496000250	1496-2	∅ 60 mm	280 - 750	1
01497000050	1497	□ 68 x 38 mm	280 - 750	1

4500 - 4502



mit 2-K Kunststoffheft / with 2-K plastic handle

Bestell-No. Order-No.	No.	tlg./pcs.	
04500000000	4500	55	1
04501000000	4501	55	1
04502000000	4502	55	1

Verkaufsständer, leer Display Stands, empty

4500-100

Bestell-No. Order-No.	für/for No.	
04500010000	4500 4501 4502	1

4511 DIN 5262 ISO 8764-2



Bestell-No. Order-No.	No.	mm	mm	
04511000180	01	-	25	10
04511000280	02	-	25	10
04511000080	0	-	60	10
04511001080	1	-	75	10
04511002080	2	-	100	10
04511003080	3	8/13	150	5
04511004080	4	10/16	200	5

4512 DIN 5262 ISO 8764-2



Bestell-No. Order-No.	No.	mm	mm	
04512000180	01	-	25	10
04512000280	02	-	25	10
04512000080	0	-	60	10
04512001080	1	-	75	10
04512002080	2	-	100	10
04512003080	3	8/13	150	5

4515



Bestell-No. Order-No.	Größe size	
04515000680	T 6	10
04515000780	T 7	10
04515000880	T 8	10
04515000980	T 9	10
04515001080	T10	10
04515001580	T15	10
04515002080	T20	10
04515002580	T25	10
04515002780	T27	10
04515003080	T30	5
04515004080	T40	5

4530

DIN 5265
ISO 2380-2



Bestell-No. Order-No.				
	mm	mm	mm	
04530010080	1,0	5,5	100	10
04530012580	1,2	6,5	125	10
04530015080	1,2	8	150	10
04530020080	1,6	10	200	5
04530025080	2,0	12	250	5
04530030080	2,5	14	300	5

4535



Bestell-No. Order-No.				
	mm	mm	mm	
04535006080	0,4	2,5	60	10
04535007580	0,5	3	75	10
04535010080	0,5	3,5	100	10
04535012580	0,8	4	125	10
04535015080	0,8	5	150	10
04535020080	0,8	5	200	10

4537



Bestell-No. Order-No.					
	mm	mm	mm	mm	
04537010080	1,0	5,5	100	5/8	10
04537012580	1,2	6,5	125	6,35/10	10
04537015080	1,2	8	150	8/13	10
04537017580	1,6	10	175	10/16	10
04537020080	2,0	12	200	10/16	5
04537025080	2,5	14	250	10/16	5

4545



Bestell-No. Order-No.				
	mm	mm	mm	
04545004080	0,8	4	25	10
04545006080	1,2	6,5	25	10

3301-1



Zur Aufnahme von Bits mit Außensechskant 1/4",
Klinge verchromt, mit 2-K Kunststoffheft
For bits 1/4"-drive, chromium plated,
with 2 component handle

Bestell-No. Order-No.	No.		
		mm	
03301010080	3301-1	200	10

4560



Bestell-No. Order-No.	tlg./pcs.	
04560000080	6	1

4561 - 4567 Schraubendreher-Sätze / Screwdriver Sets



Bestell-No. Order-No.	No.	tlg./pcs.	
04561000080	4561	⊖ 7	1
04562000080	4562	⊖ 6	1
04563000080	4563	⊖ 6	1
04564000080	4564	⊖ ⊕ 7	1
04565000080	4565	⊖ ⊕ 7	1
04566000080	4566	⊕ 6	1
04567000080	4567	⊖ ⊕ ⊕ 5	1

Sicherheitswerkzeuge / Insulated Safety Tools



1000 Volt/volt = *
EN 60900

4511 VDE



DIN 7438



Bestell-No. Order-No.	No.		
		mm	
04511001033	1	80	10
04511002033	2	100	10
04511003033	3	150	10

4536 VDE



DIN 7437



Bestell-No. Order-No.				
	mm	mm	mm	
04536007533	0,4	2,5	75	10
04536010033	0,5	3,5	100	10
04536010133	0,8	4,0	100	10
04536012533	1,0	5,5	125	5
04536015033	1,2	6,5	150	5

4550 VDE



Bestell-No. Order-No.	tlg./pcs.	
04550000033	7	1

1500



Bestell-No. Order-No.	← L → mm	"	mm	mm	
01500030080	300	12	22 x 7,0	10	
01500040080	400	16	25 x 7,5	10	
01500050080	500	20	27 x 9,0	10	
01500060080	600	24	27 x 11,0	10	

1505



Bestell-No. Order-No.	← L → mm	"	mm	mm	
01505040080	400	16	25 x 7,5	10	
01505050080	500	20	28 x 8,6	10	
01505060080	600	24	28 x 8,6	10	

1509



Bestell-No. Order-No.	Mercedes-Benz No.	← L → mm	"	mm	
01509045020	0005811758	450	18	5	
01509060020	0005812158	600	24	1	

1577 Zimmermanns-Nageleisen/ Goose neck ripping bars



Bestell-No. Order-No.	No.	← L → mm	mm	mm	
01577040000	1577-400	400	17	5	
01577050000	1577-500	500	17	5	
01577060000	1577-600	600	17	5	
01577080000	1577-800	800	19	5	
01577100000	1577-1000	1000	19	5	

103 Spezial-Hebeleisen / Special pry bars



Bestell-No. Order-No.	No.	← L → mm	mm	mm	
50210340800	103	400	14	5	

113 Hebeleisen / Pry bars



Bestell-No. Order-No.	No.	← L → mm	mm	mm	
50211340800	113	400	14	5	

1512



Glasfaserverstärkt / glass fibre reinforced

Bestell-No. Order-No.	← L → mm	mm	
91512028000	280	5	

1513 Reifen-Montierwerkzeug / Tyre Change Presser



- Hergestellt aus Polyamide, glasfaser-verstärkt
- Das hochwertige Material verspricht absoluten Schutz vor Beschädigungen an Aluminium und lackierten Felgen
- Mehr Kontaktfläche an Felgen und Reifen
- Optimale Handhabung durch Handgriff
- Polyamide, fiberglass-reinforced
- The high grade material grants full protection against damages of aluminium and coated rims
- More contact surface to the rim and tire
- Optimum handling through handle

Bestell-No. Order-No.	← L → mm	mm	
01513000000	290 x 150	1	

1520 DIN 1041



Bestell-No. Order-No.		
01520020021	200	6
01520030021	300	6
01520040021	400	6
01520050021	500	6
01520080021	800	6
01520100021	1000	6
01520200021	2000	1

1522



Bestell-No. Order-No.		lbs.	
01522050011	1/2	6	
01522075011	3/4	6	
01522100011	1	6	
01522150011	1.1/2	6	
01522200011	2	6	

1523 Kupferhammer / Copper Hammer

Neu
New



Bestell-No. Order-No.		
01523075000	750	1

1530



Bestell-No. Order-No.	Ø mm	
01530002500	25	2
01530003000	30	2
01530003500	35	2
01530004000	40	2
01530005000	50	2

1531



Bestell-No. Order-No.	Ø mm	
01531002500	25	10
01531003000	30	10
01531003500	35	10
01531004000	40	10
01531005000	50	10

1540-1



Bestell-No. Order-No.	DIN 5128	Ø mm	
01540000100	A	54	1
01540000400	A	90	1

Neu
New

Chrom-Vanadium mit Sicherheitsschlagkopf /
Chrome-Vanadium with non-spreading safety
head



1550 1551
Werkzeugsatz, 6-tlg. /
Tool-Set, 6 parts



Bestell-No. Order-No.	No.	tlg./pcs.	
0155000021	1550	6	2
0155100021	1551	6	1

1555 1555-1
Steinmeißel mit Sicherheits-
schlagkopf / Stone chisel with
non-spreading safety head



DIN 7254



1555

1555-1

Bestell-No. Order-No.	No.	mm	←L→ "	
01555012521	1555	125	5	5
01555015021	1555	150	6	5
01555017521	1555	175	7	5
01555020021	1555	200	8	5
01555025021	1555	250	10	5
01555030021	1555	300	12	5
*01555125000	1555-1	250	10	5

*1555-1 mit Handschutz / with hand guard

1556 Flachmeißel mit Sicherheits-
schlagkopf / Flat cold chisel with
non-spreading safety head

DIN 6453



Bestell-No. Order-No.	←L→ mm	mm	mm	
01556012521	125	10	12	10
01556015021	150	12	16	10
01556017521	175	14	20	10
01556020021	200	16	22	10

1557 Schlitzmeißel mit Sicher-
heitsschlagkopf / Jointing chisel
with non-spreading safety head



1557

1557-1

Bestell-No. Order-No.	←L→ mm	mm	mm	
01557023021	230	26x7	26	10
*01557123000	230	26x7	26	5

*1557-1 mit Handschutz / with hand guard

1558 Fugenmeißel mit Sicher-
heitsschlagkopf / Grooving chisel
with non-spreading safety head



1558

1558-1

Bestell-No. Order-No.	←L→ mm	mm	mm	
01558250021	250	23x13	50	5
*01558125000	250	23x13	50	5

*1558-1 mit Handschutz / with hand guard

1560 Kreuzmeißel mit Sicherheits-
schlagkopf / Cape chisel with
non-spreading safety head



DIN 6451



1560

1560-1

Bestell-No. Order-No.	mm	←L→ "	
01560012521	125	6	5
01560015021	150	6	5
01560017521	175	7	5
01560020021	200	8	5
01560025021	250	6	5
*01560125000	125	6	5

*1560-1 mit Handschutz / with hand guard

1561 Kreuzmeißel mit Sicher-
heitsschlagkopf / Cape chisel
with non-spreading safety head

DIN 6451



Bestell-No. Order-No.	←L→ mm	mm	mm	
01561012521	125	10	5	10
01561015021	150	12	6	10
01561017521	175	14	8	10
01561020021	200	16	9	10

1563 Steinmeißel mit Sicherheits-
schlagkopf / Stone chisel with
non-spreading safety head

DIN 7254



1563

1563-1

Bestell-No. Order-No.	←L→ mm	mm	mm	
01563020021	200	20x12	26	10
01563025021	250	20x12	26	10
01563030021	300	23x13	32	10
01563040021	400	23x13	32	5
*01563130000	130	20x12	26	10
*01563140000	140	23x13	32	5

*1563-1 mit Handschutz / with hand guard

1562-1 Handschutz /
Hand guards



Bestell-No. Order-No.	für/for No. mm	
01562000100	1555 250 1555 300	10

Splinttreiber mit Zapfen /
Parallel pin punches with pin

DIN 6450 C

1564



Bestell-No. Order-No.	←L→ mm	mm	∅	"	mm	
01564000621	175	6	15/64	10	12	

1565



Bestell-No. Order-No.	←L→ mm	mm	∅	"	mm	
01565000221	150	2	5/64	10	10	
01565000321	150	3	1/8	10	10	
01565000421	150	4	5/32	10	10	
01565000521	150	5	3/16	10	10	
01565000621	150	6	15/64	10	10	
01565000821	150	8	5/16	12	10	
01565001021	150	10	25/64	12	10	
01565001221	150	12	15/32	12	10	

1565-41



Bestell-No. Order-No.	∅ mm	mm	
01565100421	4,0	10	10

1566 1567 Werkzeugsatz, 6-tlg. / Tool-Set, 6 parts

184



1566

1567

Bestell-No. Order-No.	No.	tlg./pcs.	
0156600021	1566	6	2
0156700021	1567	6	1

1570 Durchschläger mit Sicherheitsschlagkopf / Taper pin punch with non-spreading safety head

184

DIN 6458 D



Bestell-No. Order-No.	mm	Ø "	mm	
01570000221	2	5/64	12	10
01570000321	3	1/8	12	10
01570000421	4	5/32	12	10
01570000521	5	3/16	12	10
01570000621	6	15/64	12	10
01570000821	8	5/16	12	10
01570001021	10	25/64	12	10
01570001221	12	15/32	12	10
01570001421	14	9/16	12	10
01570001621	16	5/8	12	10

1575 Körner mit Sicherheits- schlagkopf / Center punch with non-spreading safety head

184

DIN 7250



Bestell-No. Order-No.	mm	Ø "	mm	
01575000421	4	5/32	10	10
01575000521	5	3/16	12	10

1576 Automatischer Körner / Adjustable center punch

184





Bestell-No. Order-No.	mm	Ø "	
01576013080	2	5/64	1

1577 Nietzieher mit Sicherheits- schlagkopf / Rivet-set with non- spreading safety head

DIN 6434





Bestell-No. Order-No.			mm	mm	
01577010200	2	2,5	100	10	10
01577010300	3	3,5	100	10	10
01577010400	4	4,5	100	12	10
01577011500	5	6,0	110	12	10
01577011600	6	7,0	110	14	10

1578 Nietkopfmacher mit Sicher- heitsschlagkopf / Rivet-header with non-spreading safety head

DIN 6435



Bestell-No. Order-No.			mm	mm	
01578010200	2	3,5	100	10	10
01578010300	3	5,2	100	10	10
01578010400	4	7,0	100	12	10
01578011500	5	8,8	110	14	10
01578011600	6	10,5	110	16	10

1610 DIN 6473 B

185



Bestell-No. Order-No.	für Blätter/for blades mm	"	
01610000080	250 + 300	10 + 12	1

1615 - 1617

185



1615



1616



1617

Bestell-No. Order-No.	No.	Maße/dimensions mm	
01615030000	1615	300x13x0,63	50
01616030000	1616	300x25x0,80	50
01617030000	1617	300x13x0,65	50

1621

185



1621-1
rechtsschneidend/
right hand cutting



1621-2
linksschneidend/
left hand cutting



1621-3
gerade/straight

- Chrom-Molybdän-Stahl, phosphatiert, HRC 60-62
- Schneidekapazität: Metall bis zu 1,5 mm, Edelstahl bis zu 0,9 mm

- Chrome Molybdenum Steel, phosphated, HRC 60-62
- Cutting capacity: Metal up to 1,5 mm, Stainless up to 0,9 mm

Bestell-No. Order-No.	No.	mm	mm	
01621000132	1621-1	260	10.3/8	1
01621000232	1621-2	260	10.3/8	1
01621000332	1621-3	260	10.3/8	1

1622

186

90° abgewinkelt/bent



1622-1
rechtsschneidend/
right hand cutting



1622-2
linksschneidend/
left hand cutting

- Chrom-Molybdän-Stahl, gesandstrahlt
- Geschmiedete Klingen für eine höhere Festigkeit und längere Lebensdauer, HRC 60-62
- Schneidekapazität: Metall bis zu 1,2 mm, Edelstahl bis zu 0,7 mm

- Chrome Molybdenum Steel, sandblasted
- Forged blades for greater strength and longer durability, HRC 60-62
- Cutting capacity: Metal up to 1,2 mm, Stainless up to 0,7 mm

Bestell-No. Order-No.	No.	mm	mm	
01622000132	1622-1	260	10.3/8	1
01622000232	1622-2	260	10.3/8	1

1626

186



Bestell-No. Order-No.	mm	mm	
01626025025	250	10	1

1640

188 187



* Ersatz-Schneidrad/
Replacement cuttingwheel

Bestell-No. Order-No.	No.	mm	mm	
01640000020	1640	72	25	1
*01640100000	1640-1			1

1641

188 187



* Ersatz-Schneidrad/
Replacement cuttingwheel

Bestell-No. Order-No.	No.	mm	mm	
01641000020	1641	135	35	1
*01641100000	1641-1			1

1642

188 187



* Ersatz-Schneidrad/
Replacement cuttingwheel

Bestell-No. Order-No.	No.	mm	mm	
01642000020	1642	195	40	1
*01642100000	1642-1			1

1643

188 187

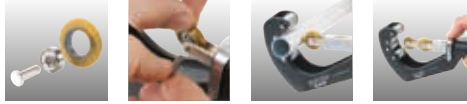

* Ersatz-Schneidrad/
Replacement cuttingwheel

Bestell-No. Order-No.	No.	mm	mm	
01643000020	1643	210	75	1
*01643100000	1643-1			1

1656

189



Bestell-No. Order-No.	Backenbreite/ width of jaws mm	Spannweite/ opening mm	
01656014560	48	28	1

1664-3

190



Bestell-No. Order-No.	Klingenbreite blade width	tlg./pcs.	
01664000300	18 mm	1	1



Automatischer
Klingenrückzug/
Automatic pull
back of the blade

Verkaufsdisplay/
Sales display
mit/with
8 Stk./pcs.

Bestell-No. Order-No.	Klingenbreite blade width	tlg./pcs.	
01664030800	18 mm	8	1



Ersatzklingen/
Spare blades
10 Stk./pcs.

Bestell-No. Order-No.	Klingenbreite blade width	tlg./pcs.	
01664301000	18 mm	10	1

SB 1664-10 SB 1664-10-2

190



Ersatzklingen/
Spare blades
10 Stk./pcs.

Bestell-No. Order-No.	No.	mm	tlg./pcs.	
01664101000	SB 1664-10	100	10	1
01664201000	SB 1664-10-2	100	10	1

SB 1664 SB 1664-2

190



Bestell-No. Order-No.	No.	mm	mm	
01664000000	SB 1664	170	250	1
01664000200	SB 1664-2	140	115	1

SB 1664-12 SB 1664-12-2

190



Verkaufsdisplay/
Sales display
mit/with
12 Stk./pcs.

Bestell-No. Order-No.	No.	tlg./pcs.	mm	
01664001200	SB 1664-12	12	3000	1
01664021200	SB 1664-12-2	12	1640	1

1659 Hartmetallschaber mit Radius / Square scraper with replaceable carbide tip



mit/with Inbusschlüssel/Allen Key

Bestell-No. Order-No.	mm	mm	mm	
01659030000	300	20	2	1
01659035000	350	25	2	1
01659035100	350	30	2	1
* 01659120200	25	20	2	3
* 01659125200	25	25	2	3
* 01659130200	25	30	2	3

* Hartmetall-Schaberplatte mit Radius/
Carbide scraper tip ready ground and lapped for square scraper

1660



Bestell-No. Order-No.	mm	mm	
01660020021	200	8	10
01660025021	250	10	10

1661



Bestell-No. Order-No.	mm	mm	
01661020021	200	8	10
01661025021	250	10	10

1662



Bestell-No. Order-No.	mm	mm	
01662020021	200	8	10
01662025021	250	10	10

1663



Bestell-No. Order-No.	mm	mm	
01663020021	200	8	10
01663025021	250	10	10

1665



Bestell-No. Order-No.	mm	mm	
01665028060	170	6,3/4	10

1667



Bestell-No. Order-No.	mm	mm	
01667028060	280	11	10

1668



Bestell-No. Order-No.	mm	mm	
01668000000	85	3,1/2	10

1669 Sicherheits-Rettungs- messer/ Safety folding survival knife



- Hochwertiger Messerstahl
- Gürtelclip
- Gurtschneider
- Scheibenzertrümmerer
- Wellenschliff mit Sägeverzahnung
- genarbte Kunststoffeinlagen, Edelstahlschrauben
- High grade cutlery steel
- Belt clip
- Seatbelt cutter
- Window pane breaker
- Serrated blade with saw teeth
- grained plastic inlays, screws made of stainless steel

Bestell-No. Order-No.	mm	mm	mm	
01669000000	85	3,1/2	200	1

1670



Bestell-No. Order-No.	No.	mm	
01670000161	1670-M	230	10
01670000261	1670-UNF (NF)	230	10

1675 - 1679



Bestell-No. Order-No.	No.	mm	mm	passendes Heft suitable handle	
01675020000	1675	200	8	1681-4	10
01675025000		250	10	1681-5	5
01676020000	1676	200	8	1681-4	10
01676025000		250	10	1681-5	5
01677020000	1677	200	8	1681-3	10
01677025000		250	10	1681-5	5
01678020000	1678	200	8	1681-3	10
01678025000		250	10	1681-6	5
01679020000	1679	200	8	1681-3	10
01679025000		250	10	1681-7	5

1681



Bestell-No. Order-No.	No.	mm	Innen/inside Ø mm	
01681000300	1681-3	93	6,5	10
01681000400	1681-4	93	8,0	10
01681000500	1681-5	118	11,0	10
01681000600	1681-6	118	6,5	10
01681000700	1681-7	118	8,0	10

1686 1686-1



Bestell-No. Order-No.	No.	mm	mm	tlg./pcs.	
01686000030	1686	150	6	6	10
01686000130	1686-1	150	6	1	5

1689



Bestell-No. Order-No.	mm	mm	tlg./pcs.	
01689000030	150	6	6	10

1702



193

Bestell-No. Order-No.	No.	Spannbereich/capacity mm	Höhe/depth mm	
01702000100	1702-1	57-125	2.1/4-5	80 1
01702000200	1702-2	90-175	3.1/2-7	80 1
01702000300	1702-3	90-175	3.1/2-7	165 1

1706



193

Bestell-No. Order-No.	No.	für Kolbenringe mm	
01706010055	1706-1	50-100	2-4 1
01706015055	1706-3	90-150	3.1/2-6 1

1721



193



120 Lumen

Bestell-No. Order-No.	No.	← L → mm	
01721000000	1721	300	1

1721-1



194

70 Lumen



Bestell-No. Order-No.	No.	← L → mm	
01721000100	1721-1	110	1

1731 1731-1
Schutzbrille mit Sehglasaufnahme / Protective Glasses with Eyeglass-Holder

1731 "Sport"

CE EN 166
ANSI Z87.1

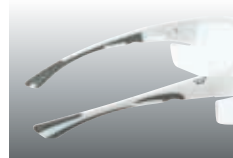

Neu
New

1731-1 "Konventionell"

CE EN 166
ANSI Z87.1

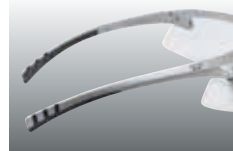

Neu
New

- Zertifizierte Produktion
- Integrierter, herausnehmbarer Brillenrahmen zur Aufnahme Ihrer individuellen Sehgläser
- Angenehmer Tragekomfort durch 2-K Weichkomponente an den Bügeln
- Auch ohne Sehglasaufnahme als Schutzbrille nutzbar

- Certified production
- Integrated, removeable spectacle frame as holder for your individual glasses
- 2-K soft component on the temple arms for high wearing comfort
- Can be used as protective glasses without eyeglass-holder

Bestell-No. Order-No.	No.	Modell	
01731000000	1731	Sport	1
01731000100	1731-1	Konventionell	1

849 Bunsenbrenner / Bunsen burner



Bestell-No. Order-No.	
08490009500	1300°C 1

1754



194

Bestell-No. Order-No.	Kratzenband/card brush mm	
01754000000	115 x 40	5

1755



194

Bestell-No. Order-No.	Reihen/rows	
01755000300	3	5
01755000400	4	5

1759



194

Bestell-No. Order-No.	Reihen/rows	
01759000300	3	10

1781 1782-2



195

Bestell-No. Order-No.	No.	Volumen/volume ccm	1/16 pint	
01781002500	1781	25	1/16	10
01782025000	1782-2	250	1/2	20

1783



195

Bestell-No. Order-No.	Volumen/volume ccm	
01783030020	300	12

HEYCO



www.heyco-tools.de

Ihr Partner rund um die Wartung von Kraftfahrzeugen

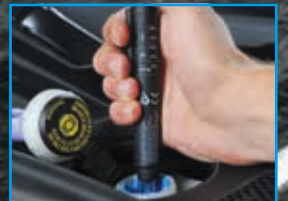
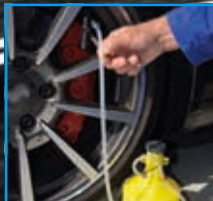

Your Partner around Car Service

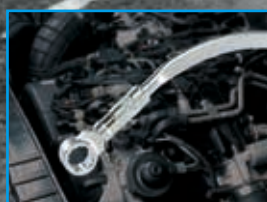

1790-1 DIN 1283

195



Bestell-No. Order-No.	ccm Inhalt/capacity lose/bulk	ccm Kartusche/cartridges	
01790000120	500	400	1

1805 Lochkreis-Messschieber/ Bolt Circle Measuring Gauge

195



- Für Lochkreis-Messungen an Stahl- und Alufelgen
- Einfaches Ermitteln des Lochkreises
- Geeignet für 3-, 4-, 5- und 6-Loch Felgen
- Messwerte-Ermittlung in mm
- Feststellschraube zum Fixieren des Messwertes
- Hochwertige Aluminium-Ausführung
- For taking measurements on bolt circles of steel- and aluminium rims
- Easy determination of the bolt circle
- Suitable for 3-, 4-, 5- and 6-hole rims
- Value indication in mm
- Locking screw for fixation of the value
- High grade aluminium version

Bestell-No. Order-No.	mm		
01805024000	84		1

1806 DIN 862

196



Bestell-No. Order-No.	mm		Nonius/vernier mm	
01806015080	140	5.1/2	1/20 1/128	5

1807

196



Bestell-No. Order-No.	mm		Nonius/vernier mm	
01807015080	150	5.1/2	1/20 1/128	1

1814

196



Bestell-No. Order-No.	No.	tlg./pcs.	Meßbereich/ measuring range	
01814000240	1814-2	13	0,05-1,0 mm	10
01814000340	1814-3	18	0,05-1,0 mm	10
01814000440	1814-4	20	0,05-1,0 mm	10
01814001240	1814-12	13	.002-.035"	10
01814001340	1814-13	22	.004-.025"	10

1815 2 in 1 Brems Scheiben- Messschieber und Reifenprofil- Messlehre/ 2 in 1 Brake- and Tyre Profile-Calliper

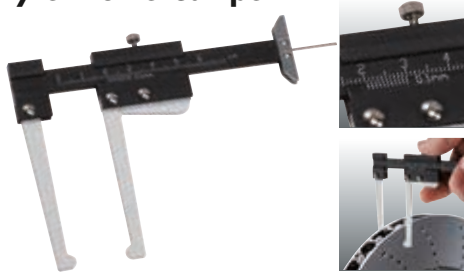

- Zum Messen der Brems Scheibenstärke bei PKW + Motorrädern im eingebauten Zustand
- Aus rostfreiem Stahl
- Mit Feststellschraube und zusätzlicher Reifenprofil- Messlehre
- Meßbereich: 0-60mm
- For measuring the thickness of built-in braking discs of passenger cars and motorbikes
- Made of stainless steel
- With locking screw and additional tyre profile-calliper
- Measuring range: 0-60mm

Bestell-No. Order-No.	Meßbereich/ measuring range	
01815007500	0-60 mm	1

1836

196



Bestell-No. Order-No.	mm		
01836030000	300	12	10

1837 Holzgliedermaßstab, 2 m/ Beechwood Folding Rule, 2 m

196

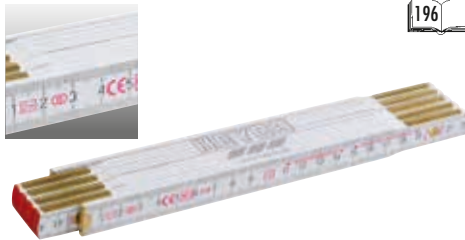

Genauigkeitsklasse EG III, aus Buchenholz, Gliederstärke 3,0 mm, Gliederhöhe 16 mm, Gliederzahl 10, durchgenietete Gelenke und vermessingte Stahlfedern, 2 m Länge

EC accuracy class III, beechwood, section thickness 3,0 mm, section height 16 mm, no of sections 10, riveted and brass-plated, spring joints, 2 m length

Bestell-No. Order-No.	Meßbereich/ measuring range	
01837020000	200	1

1840

197



Bestell-No. Order-No.	Meßbereich/ measuring range		
01840500000	5 m	325	1
01840800000	8 m	470	1

SB 1840-12

197



Verkaufsdisplay / Sales display
mit/with 12 Stck./pcs.
Heyco No. 1840

Bestell-No. Order-No.	Meßbereich/ measuring range		
01840051200	5 m	3900	1
01840081200	8 m	5800	1

1842

198



Bestell-No. Order-No.	mm		
01842025030	250	10	10

1856

198



Bestell-No. Order-No.	No.	Meßbereich/measuring bar	lbs./sq. in	
01856000383	1856-3	0,5-3,5	6-50	10
01856000483	1856-4	0,8-8,2	10-120	10

1857

198



inkl. Batterie
incl. battery

Lieferung in Blisterverpackung
Delivery in blister packaging

Profiltiefe-Messung / Measuring tread depth: 0,22 mm / 8"

Reifendruck-Messung / Measuring pressure:
0-7,0 Bar / 0-100 PSI / 0-7,0 kg/cm

Genauigkeit / Accuracy: +/- 1%

Bestell-No. Order-No.	
01857000000	12

1905

198



Bestell-No. Order-No.	Spitze/probe tip mm	
01905000000	195	1

1920

199



Bestell-No. Order-No.		
01920100000	10	10

2010-3 Achsölwanne / Drain Pan for axle oil



Bestell-No. Order-No.	L	
02010000300	3	1

2010-8

199



L: 520 mm
H: 140 mm
Ø: 320 mm

Bestell-No. Order-No.	L	
02010000800	8	1

2010-10

199



567 x 321 x 126 mm

Bestell-No. Order-No.	L	
02010001000	10	1

2011

200



Bestell-No. Order-No.	L	
02011000000	1	1

2012

200



Bestell-No. Order-No.		
02012000000	3 kg	1

2013 Bremsflüssigkeitstester / Brake Fluid Tester

200



inkl. Batterie
incl. battery
1,5 V AAA



- Ermittelt die Qualität der Bremsflüssigkeit
- Zeigt an, wie groß der Wasseranteil in der Bremsflüssigkeit ist und dementsprechend, wann die Bremsflüssigkeit gewechselt werden soll
- Can be used as a digital brake fluid tester suitable for determining brake fluid quality
- Tested and indicated on five LEDs in terms of „per cent of water in the brake fluid“

Bestell-No. Order-No.		
02013000000	145	1

2014 Lambdasonde-Spezialwerk- zeug / Lambda Sensor-Special Tools



Spezialwerkzeug für
Lambdasonden an VW, Audi,
BMW, Mercedes, Ford, Opel,
Vauxhall, Peugeot, Citroen,
Renault, Seat, Skoda etc.

Special Tool for Lambda-
Sensors for VW, Audi, BMW,
Mercedes, Ford, Opel,
Vauxhall, Peugeot, Citroen,
Renault, Seat, Skoda ...



Bestell-No. Order-No.			
02014002280	250	22	1

2015 Universal Keil- und Zahn- riemenschlüsselsatz/ Universal V-Belt- and Cam Belt- Wrench Set



Bestell-No. Order-No.	enthaltend/containing	tlg./pcs.	
02015000080	2015-500 2015-20, 2015-30	10	1

2015-500 Universal Keil- und Zahnriemenschlüssel / Universal V-Belt and Cam Belt- Wrench



Bestell-No. Order-No.		
02015050080	500	1

2015-20 Torx-Einsteckschlüssel für Univ. Keil- und Zahnriemen- schlüssel / Torx Wrench Insert Tool for Universal V-belt and cam belt-wrench



Bestell-No. Order-No.		
02015201080	E 10	1
02015201280	E 12	1
02015201480	E 14	1
02015201680	E 16	1
02015201880	E 18	1

2015-30 Einsteckringschlüssel für Keil- und Zahnriemenschlüs- sel / Ring Wrench Insert Tool for Universal V-belt and cam belt- wrench



Bestell-No. Order-No.		
02015301280	12x14	1
02015301380	13x15	1
02015301680	16x17	1
02015301880	18x19	1

2145

201



Bestell-No. Order-No.	Saugkopf suction cup	Tragkraft capacity	
0214500000	∅ 120 mm	80 kg	1

2165

201



Bestell-No. Order-No.	∅ mm	
02165003200	32	2
02165003500	35	2
02165004000	40	2
02165005000	50	2

2166

für/for HEYCO 2165

201



Bestell-No. Order-No.	∅ mm	
02166003200	32	10
02166003500	35	10
02166004000	40	10
02166005000	50	10

2240

202



Bestell-No. Order-No.	No.			
02240001060	2240-10	80	100	1
02240002060	2240-20	120	100	1
02240003060	2240-30	160	150	1
02240004060	2240-40	200	150	1
02240005060	2240-50	250	200	1
02240006060	2240-60	350	200	1

2243

202



Bestell-No. Order-No.	No.			
02243001060	2243-10	80	90	1
02243002060	2243-20	130	90	1
02243003060	2243-30	160	150	1
02243004060	2243-40	200	150	1
02243005060	2243-50	250	200	1
02243006060	2243-60	350	200	1
02243007070	2243-70	520	200	1

2246

202



Bestell-No. Order-No.	enthaltend/containing	tlg./pcs.	
02246000060	2243-10, 2243-20 2243-30, 2243-40 2243-50	5	1

2252 - 2253

203



2252 2253

Bestell-No. Order-No.	No.			
02252000160	2252-1	150	80	1
02252000260	2252-2	200	130	1
02253000160	2253-1	150	80	1
02253000260	2253-2	200	130	1

2255 - 2256

203



2255 2256

Bestell-No. Order-No.	No.			
02255000060	2255-0	100	85	1
02255000160	2255-1	200	150	1
02255000260	2255-2	250	220	1
02255000360	2255-3	300	240	1
02256000060	2256-0	100	85	1
02256000160	2256-1	200	150	1
02256000260	2256-2	250	220	1
02256000360	2256-3	300	240	1
02256003160	2256-31	350	350	1
02256000460	2256-4	400	400	1
02256000560	2256-5	500	500	1

2257-4

204/205



Bestell-No. Order-No.	No.			
02257000480	2257-4	102	76	1

2257-7

204/205



Bestell-No. Order-No.	No.			
02257000780	2257-7	178	76	1

2270-21

205



Bestell-No. Order-No.	für Bolzen for stud		
02270002160	∅ 4-20 mm	22	1

2276

205

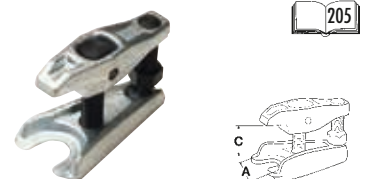

Bestell-No. Order-No.	A mm	C mm	
02276000060	18-22	15-50	1

HEYCO No.	Seite Page	HEYCO No.	Seite Page	HEYCO No.	Seite Page	HEYCO No.	Seite Page	HEYCO No.	Seite Page	HEYCO No.	Seite Page
25-00-10	20	43-80	23	70-0	27	K 350	16	K 895	17	1171-8-1	46
25-01-1	20	43-1010	23	70-0010	27	R 350	16	896	39	1172	46
25-03	20	43-3010	23	70-30	27	370	17	K 896	39	1172-8-1	46
25-04	20	44-0010	23	70-50	27	380	17	R 896-9	39	1174	46
25-05	20	44-50	23	70-80	27	390	17	900	39	1174-11	46
25-05-1	20	44-80	23	70-1010	27	392	17	910	39	1176-1	47
25-05-5	20	44-3010	23	70-3010	27	400	17	911	39	1176-2	47
25-06	20	45-0010	23	72-4010	30	B 400	17	933	39	1176-3	47
25-07	20	45-50	23	72-4310	30	HP 400-12	17	942	39	1177-1-1	47
25-08	20	45-80	23	73-03	30	K 400	17	943	39	1177-1-2	47
25-11	20	45-3010	23	73-33	30	R 400	18	960-7	44	1177-1-3	47
25-15	20	47-0010	23	73-0310	30	410	18	961-7	44	1177-1-5	47
25-16	20	49-5 VDE	48/55	73-3310	30	K 410	18	965-9	44	1177-2-3	47
25-19	21	49-8	54	75-0	30	430	18	968-8	44	1177-2-4	47
25-20	21	50-00-1	23	75-0010	30	450	18	969-10	44	1178-1-2	47
25-6	20	50-00-7	23	75-0310	30	K 450	18	E 970-3	43	1178-1-3	47
25-30	21	50-00-10	23	75-10	30	475	18	970-10	44	1178-1-4	47
25-31	21	50-00-18	23	75-30	30	K 475	18	971-17	44	1178-1-5	47
25-32	21	50-00-27	23	75-50	30	R 475	18	972-14	44	1179-1-1	47
25-35	21	50-02	23	75-60	30	493	19	973-8	44	1179-1-2	47
25-36	21	50-03	23	75-80	30	R 493	19	975-3010	44	1186	46
25-50	21	50-04	23	75-1010	30	495	19	980-14	44	1187	46
25-70	21	50-04-1	23	75-3010	30	497	19	984-3800	44	1200	47
27-80	21	50-04-5	23	75-3110	30	501	35	985-0010	45	1200 VDE	48
27-90	21	50-04-25	23	75-3310	30	503	35	985-3010	45	1206	47
27-3010	21	50-05	23	76-0010	30	510	35	990-4	45	1206 VDE	48
27-3510	21	50-05-5	23	77-0	30	530	38	990-4-1	45	1207	47
27-4010	21	50-06	24	77-30	30	B 530	38	991-7	45	1207 VDE	48
29-3010	21	50-08	24	78-0	30	K 530	38	991-8	45	1208	47
30-3010	21	50-09	24	78-0010	30	531	38	991-8-1	45	1208 VDE	48
31-1910	21	50-6	24	78-30	30	531-19	38	992-4	45	1209	47
40-00-1	22	50-10	24	78-3010	30	531-5-1	38	995-8	45	1209 VDE	48
40-00-7	22	50-12	24	79-0010	30	531-5-2	39	1000	39	1212	48
40-00-10	22	50-14-1	24	79-0310	30	541	39	1000-914-M	40	1213	48
40-00-27	22	50-15	24	79-3010	30	545	39	1000-915-M	40	1213 VDE	48
40-02	22	50-16	24	79-3310	30	600-10	35	1002	39	1215	48
40-03	22	50-19	24	84-0010	30	610	38	1002-910	43	1220	48
40-04	22	50-19-1	24	84-3010	30	664	34	1052	48	1220 VDE	48
40-04-1	22	50-19-3	24	94-2550	30	665	34	1090	45	1230	48
40-04-15	22	50-20	24	100-00-5	31	666	34	1090-1	45	1231	48
40-04-25	22	50-30	24	100-00-6	31	695-1	35	1101	40	1232	49
40-05	22	50-31	24	100-01-1	31	762	34	1101-911	43	1233	49
40-06	22	50-32	24	100-03-1	31	764	34	1127-1	40	1250	49
40-07	22	50-33	27	100-03-5	31	765	34	1127-2	40	1252	49
40-6	22	50-34	27	100-03-6	31	766	34	1127-3	43	1255	49
40-12	22	50-35	27	100-03-8	31	776	35	1128	43	1256	49
40-14	22	50-36	27	100-04	31	778	35	1128-3	44	1257	49
40-15	22	50-40-10	23	100-05	31	779	35	1128-8	44	1258	49
40-16	22	50-50	27	100-06	31	782	34	1128-8-5	43	1261	49
40-17-1	22	50-55-2	27	100-07	31	784	34	1128-8-9	43	1261-1	49
40-17-2	22	50-58	27	100-6	31	785	34	1128-8-15	43	1261-10	50
40-18-1	22	50-65	27	100-12	31	786	34	1128-933	43	1261-30	50
40-18-2	22	50-75	27	100-14	31	792	34	1128-942	43	1261-40	50
40-19-1	22	50-76	27	100-15	31	792-10	34	1128-943	43	1261-50	50
40-19-2	22	50-77	27	100-16	31	792-18	34	1129	43	1261-60	50
40-19-3	22	50-80	27	101-0	31	792-21	34	1129-8-1	43	1261-31	50
40-20	22	50-80-1	27	101-10	31	792-31	34	1129-8-2	43	1261-41	50
40-30	22	50-80-2	27	101-30	31	792-41	34	1129-8-3	43	1261-51	50
40-31	22	50-80-3	27	101-50	31	792-51	34	1129-8-4	43	1261-61	50
40-32	23	50-80-4	27	101-60	31	794	34	1129-8-5	43	1261-32	50
40-35	23	50-80-10	27	101-80	31	794-10	34	1129-8-6	43	1261-42	50
40-36	23	50-80-20	27	103	58	794-21	34	1129-8-7	43	1261-52	50
40-50	23	50-80-30	27	105-00-6	31	794-31	35	1129-8-8	43	1261-62	50
40-70	23	50-80-40	27	105-03	31	794-41	35	1129-8-12	43	1262	50
40-71	23	50-85	27	105-04	31	795	34	1129-8-15	43	1262-1	50
40-75	23	50-86	27	105-05	31	795-20	35	1135	43	1262-10	50
40-76	23	50-87	27	105-12	31	796	34	1135-933	43	1262-24-1	50
40-85	23	50-90	27	105-14	31	800	19	1140	43	1262-32-1	50
40-88	23	50-95	27	106-0	31	808	19	1140-933	43	1262-40-1	50
41-0010	23	50-96	27	113	58	810	19	1140-942	43	1262-48-1	50
41-50	23	50-97	27	300	47	820	20	1140-943	43	1262-24-2	50
41-80	23	50-100	27	313	47	840	20	1170	46	1262-32-2	50
41-1010	23	57-0010	27	315	47	845	20	1170-8-1	46	1262-40-2	50
41-3010	23	67-50	27	350	16	849	63	1170-8-2	46	1262-48-2	50
43-0010	23	67-52 AF	27	B 350	16	894	16	1170-11	46	1280	50
43-50	23	67-80	27	HP 350-8	16	895	16	1171	46	1280-L	50

HEYCO No.	Seite Page	HEYCO No.	Seite Page	HEYCO No.	Seite Page	HEYCO No.	Seite Page	HEYCO No.	Seite Page
1281	51	1450 VDE	55	1615	60	1755	63	2246	68
1282	51	1452	54	1616	60	1759	63	2252-1	68
1285	51	1454	54	1617	60	1781	63	2252-2	68
1286	51	1456	55	1621-1	60	1782-2	63	2253-1	68
1286-ST	51	1458	55	1621-2	60	1783	63	2253-2	68
1286-4	51	1460	55	1621-3	60	1790-1	66	2255-0	68
1287	51	1470	54	1622-1	60	1805	66	2255-1	68
1287-24	51	1479	55	1622-2	60	1806	66	2255-2	68
1327-1	51	1480	56	1626	61	1807	66	2255-3	68
1327-2	51	1483	56	1640	61	1814-2	66	2256-0	68
1328	51	1484	56	1640-1	61	1814-3	66	2256-1	68
1329-3	51	1491	56	1641	61	1814-4	66	2256-2	68
1329-4	51	1494-1	56	1641-1	61	1814-12	66	2256-3	68
1330	51	1494-2	56	1642	61	1814-13	66	2256-31	68
1333	51	1494-3	56	1642-1	61	1815	66	2256-4	68
1335	52	1495-3	56	1643	61	1836	66	2256-5	68
R 1335-6	52	1496-2	56	1643-1	61	1837	66	2257-4	68
1337	52	1497	56	1659	62	1840	66	2257-7	68
R 1337-6	52	1500	58	1660	62	SB 1840-12	66	2270-21	68
1340	52	1505	58	1661	62	1842	66	2276	68
H 1340	52	1509	58	1662	62	1856-3	66	3301-1	31/57
HP 1340-9	52	1512	58	1663	62	1856-4	66	3305	31
K 1340	52	1520	58	SB 1664	61	1857	66	3310	32
R 1340	52	1522	58	SB 1664-2	61	1905	66	3700	32
1341	53	1523	58	1664-3	61	1920	66	3700-19	32
HP 1343-9	53	1530	58	SB 1664-12	61	2010-3	67	3704-15	32
1345	53	1531	58	SB 1664-12-2	61	2010-8	67	3704-25	32
R 1345-7	53	1540-1	58	SB 1664-10	61	2010-10	67	3705-50	32
1347	53	1550	59	SB 1664-10-2	61	2011	67	3800	32
R 1347-6	53	1555	59	1665	62	2012	67	3800-19	32
1348	53	1555-1	59	1667	62	2013	67	3800-9015	32
H 1348-8	53	1556	59	1668	62	2014	67	3804-25	32
R 1348-10	53	1557	59	1669	62	2015	67	3804-50	32
HP 1349-8	53	1558	59	1670	62	2015-20	67	3805-50	32
1360	39	1560	59	1675	62	2015-30	67	3806-10	32
1405	54	1561	59	1676	62	2015-500	67	4500	56
1411	54	1562-1	59	1677	62	2145	68	4500-100	56
1411 VDE	55	1563	59	1678	62	2165	68	4501	56
1412	54	1564	59	1679	62	2166	68	4502	56
1415	54	1565	59	1681	62	2199	40	4511	56
1417	54	1565-41	59	1686	62	2240-10	68	4511 VDE	57
1419	55	1566	60	1686-1	62	2240-20	68	4512	56
1420	55	1567	60	1689	62	2240-30	68	4515	57
1424	55	1570	60	1702-1	63	2240-40	68	4530	57
1425	55	1575	60	1702-2	63	2040-50	68	4535	57
1426 VDE	55	1576	60	1702-3	63	2040-60	68	4536 VDE	57
1427 VDE	55	1577	60	1706-1	63	2243-10	68	4537	57
1430	54	1577-400	58	1706-3	63	2243-20	68	4545	57
1435	54	1577-500	58	1721	63	2243-30	68	4550 VDE	57
1436	54	1577-600	58	1721-1	63	2243-40	68	4560	57
1436 VDE	55	1577-800	58	1731	63	2243-50	68	4561	57
1437	54	1577-1000	58	1731-1	63	2243-60	68	4562	57
1445	54	1610	60	1754	63	2243-70	68	4563	57
								4564	57
								4565	57
								4566	57
								4567	57
								6101-30	20
								6201-30	22
								6300	32
								6300-19	32
								6300-20	33
								6300-31	33
								6300-36	33
								6301-1	33
								6301-2	33
								6301-3	33
								6301-4	33
								6301-10	33
								6301-20	33
								6301-22	33
								6301-40-1	33
								6301-40-2	33
								6301-41-1	33
								6301-41-2	33
								6500	33
								6500-19	33
								6501-3	33
								6501-4	33
								6501-5	33
								6501-10	33
								6501-20	33
								6501-22	33
								6501-40	33
								6501-41	33
								6600	33
								6600-19	33
								6601-3	33
								6601-4	33
								6601-5	33
								6601-10	33
								6601-20	33
								6601-40	33
								6601-41	33
								6700	34
								9871025	21
								9871040	23
								9871050	27

Administrative HEYCO-Ident-Nummern / Administrative HEYCO-Identification-Numbers

UST-IdNr. / VAT Reg. Number : DE 1208 10068

BIC : COBADEFFXXX

IBAN : 49340400490762047900

DUNS-Nr. : HEYCO Holding GmbH 315572748

: HEYCO-WERK Remscheid Birgden 315941872

: HEYCO-WERK Remscheid Bergisch-Born 333601545

: HEYCO-WERK SÜD Tittling 314327891

: HEYCO-WERK Ireland Ltd. 219662723

: HEYCO-WERK CR s.r.o. 366947856

Bestell-No. Order-No.	EAN 402 40 89 +	Bestell-No. Order-No.	EAN 402 40 89 +
00025000483	000177	00025632583	001136
00025000583	000184	00025700083	366716
00025000683	000191	00027301083	099683
00025000783	000207	00027351083	096736
00025000883	000214	00027401083	099690
00025000983	000221	00027800083	001242
00025001083	000238	00027900083	001266
00025001183	000245	00029301083	099706
00025001283	000252	00030301083	114003
00025001383	000269	00031191083	366488
00025001483	000276	00040006583	099089
00025004583	000283	00040000783	099072
00025005583	000290	00040000883	098471
00025010083	000320	00040000983	098488
00025011083	000337	00040001083	098495
00025030083	000351	00040001183	098501
00025040083	000375	00040001283	098518
00025050083	000382	00040001383	098525
00025051083	000399	00040001483	098532
00025050583	112849	00040001583	098549
00025060083	000405	00040001683	098556
00025070083	000412	00040001783	098563
00025080083	000429	00040001883	098570
00025110083	113846	00040001983	098587
00025150083	000559	00040002083	098594
00025160083	000566	00040002183	098600
00025190483	365146	00040002283	098617
00025190583	365160	00040007082	001488
00025190683	365184	00040010083	001501
00025190783	365191	00040011082	001518
00025190883	365207	00040017082	001556
00025190983	365214	00040202083	098235
00025191083	365221	00040207082	001563
00025191183	365238	00040300083	098242
00025191283	365245	0004031283	098624
00025191383	365252	0004031483	098631
00025191483	365269	0004031683	098648
00025194583	365153	0004031883	098655
00025195583	365177	0004031983	098662
00025200483	000733	00040032183	098679
00025200583	000740	00040032383	098686
00025200683	000757	00040032583	098693
00025200883	000771	00040032683	098709
00025201083	000788	00040032783	098716
00025201183	000795	00040032883	098723
00025200283	000801	00040032983	098730
00025200383	000818	00040033183	098747
00025200483	000825	00040033283	098754
00025200583	000832	00040033383	098761
00025200683	094343	00040033483	098778
00025201083	000849	00040040083	098259
00025201283	000856	00040041083	099119
00025201383	000863	00040041583	103021
00025201483	000870	00040042583	103038
00025201583	000887	00040050083	098266
00025213083	094558	00040055083	103045
00025213183	094565	00040060083	098273
00025213283	094572	00040070083	098280
00025213383	094589	00040140083	098297
00025213483	094596	00040150083	098303
00025213683	094602	00040160083	098310
000252320183	000894	00040170183	394221
000252320283	000900	00040170283	394238
000252320383	000917	00040180183	394061
000252320483	000924	00040180283	394085
000252350183	094473	00040190183	098785
000252350283	094480	00040190283	098792
000252350383	094497	00040190383	098808
000252350483	094503	00040200583	112771
000252360683	094527	00040200683	112788
000252360783	094510	00040200783	112795
000252360883	000931	00040200883	112801
000252360983	000948	00040201083	112818
000252361083	000955	00040201283	112825
000252361583	000962	00040201483	112832
000252362083	000979	00040300183	001709
000252362583	000986	00040300283	001716
000252362783	094534	00040300383	001723
000252363083	000993	00040310183	001730
000252364083	094541	00040310283	001747
00025250083	125337	00040310383	001754
000252630583	001020	00040310483	001761
000252630783	001037	00040310583	001778
000252630883	001044	00040310783	172270
000252631083	001051	00040310883	172263
000252631283	001068	00040313083	001785
000252631483	001075	00040313183	001792
000252631683	001082	00040313283	001808
000252631883	001099	00040313383	001815
000252631983	001105	00040313483	001822
000252632183	001112	00040313683	001839
000252632383	001129	00040313883	001846

Bestell-No. Order-No.	EAN 402 40 89 +	Bestell-No. Order-No.	EAN 402 40 89 +
00040320183	001853	00050018082	002836
00040320283	001860	00050020083	002843
00040320383	001877	00050027082	002850
00040350183	001891	00050030083	002874
00040350283	001907	00050031983	002881
00040350383	001914	00050032183	002904
00040361083	001938	00050032383	002928
00040361583	001945	00050032583	002942
00040362083	001952	00050032683	002959
00040362583	001969	00050032783	002966
00040362783	001976	00050032983	002980
00040363083	001983	00050033183	002997
00040364083	001990	00050033283	003000
00040364583	002003	00050033383	003017
00040365083	002010	00050033483	003031
00040500083	125344	00050033583	003048
00040600683	099058	00050033683	003055
00040600783	099065	00050033783	003062
00040600883	098327	00050033883	003079
00040600983	098334	00050033983	003086
00040601083	098341	00050034083	003093
00040601183	098358	00050034183	003109
00040601283	098365	00050040083	003130
00040601383	098372	00050041083	003154
00040601483	098389	00050042583	103052
00040601583	098396	00050045083	103069
00040601683	098402	00050050083	003185
00040601783	098419	00050055083	103076
00040601883	098426	00050060083	003215
00040601983	098433	00050070383	003239
00040602083	098440	00050070483	003246
00040602183	098457	00050070583	003253
00040602283	098464	00050070683	003260
00040700083	366723	00050070783	003277
00040701083	366730	00050070883	003284
00040750083	098815	00050070983	003291
00040760083	098822	00050071083	003307
00040850083	098839	00050071183	003314
00040880083	098846	00050071283	003321
00041001083	100402	00050071383	003338
00041101083	100419	00050080083	003352
00041301083	100426	00050090083	003369
00041500083	098884	00050100083	003376
00041800083	098907	00050141083	003383
00043001083	100433	00050150083	003390
00043101083	100446	00050160083	003406
00043301083	100471	00050190182	003413
00043500083	098945	00050190382	003444
00043800083	098969	00050191082	099874
00044001083	097368	00050191182	099881
00044301083	095319	00050191282	003451
00044500083	100532	00050191382	003468
00044800083	100549	00050191482	003475
00045001083	100556	00050191582	003482
00045301083	100563	00050191682	003499
00045500083	098990	00050191782	003505
00045800083	099003	00050191882	003512
00047001083	329650	00050191982	003529
00049000500	002188	00050192182	003536
00049000500	002188	00050192282	003543
00049000880	002195	00050192482	003550
00050000120	002317	00050192682	003567
00050000883	002331	00050192782	003574
00050000983	002348	00050193082	003581
00050001083	002362	00050193282	003598
00050001183	002379	00050195282	003611
00050001283	002393	00050195482	003635
00050001383	002416	00050195582	003642
00050001483	002430	00050195682	003659
00050001583	002454	00050195782	003666
00050001683	002478	00050201083	003697
00050001783	002492	00050201183	003703
00050001883	002508	00050201283	003710
00050001983	002522	00050201483	003727
00050002083	002539	00050201683	003734
00050002183	002546	00050201883	003741
00050002283	002553	00050202083	003758
00050002383	002560	00050202483	003765
00050002483	002584	00050300183	003789
00050002583	002591	00050300283	003796
00050002683	002607	00050300383	003802
00050002783	002614	00050300483	003819
00050002883	002621	00050300583	003826
00050002983	002638	00050310183	003833
00050003083	002645	00050310283	003840
00050003283	002652	00050310383	003857
00050003383	002669	00050310483	003864
00050003483	002676	00050310583	003871
00050007082	002690	00050310683	003888
00050001083	002744	00050310783	003895
00050011082	002782	00050310883	003901
00050017082	002829	00050310983	003918

Bestell-No. Order-No.	EAN 402 40 89 +	Bestell-No. Order-No.	EAN 402 40 89 +
00050311083	003925	00050780083	366693
00050311183	003932	00050790083	366709
00050311283	003949	00050800020	004977
00050311383	003956	00050800100	004984
00050311483	003963	00050800200	004991
00050311583	003970	00050800300	005004
00050311683	003987	00050800400	005011
00050311783	003994	00050801060	005035
00050311883	099898	00050802060	005042
00050311983	099904	00050803020	005059
00050313283	004007	00050804000	005066
00050313483	004014	00050805083	005073
00050313683	004021	00050806083	005080
00050313883	004038	00050807083	005097
00050314083	004045	00050900020	005110
00050314283	004052	00050950083	005127
00050314483	004069	00050960083	005134
00050315083	004076	00050970083	005141
00050320283	004083	00057001083	329667

Bestell-No. Order-No.	EAN 402 40 89 +	Bestell-No. Order-No.	EAN 402 40 89 +
00100033580	006810	00350131782	008692
00100033780	006827	00350141582	008722
00100033880	006834	00350141782	008753
00100033980	006841	00350161782	008777
00100034080	006858	00350161882	008791
00100034180	006865	00350171982	008821
00100034280	006872	00350181982	008845
00100034380	006889	00350182182	008869
00100034480	006896	00350192282	008890
00100034580	006902	00350192482	008913
00100034780	006919	00350202282	008937
00100034880	006926	00350212382	008951
00100034980	006933	00350212482	008975
00100035080	006940	00350222482	009002
00100035180	006957	00350242682	009026
00100035280	006964	00350242782	009057
00100040080	006971	00350243082	009071
00100050080	006988	00350252882	009095
00100060080	006995	00350272982	009118
00100070080	007008	00350273082	009132
00100140080	007015	00350273282	009156
00100150080	007022	00350303282	009187
00100160080	007039	00350303482	009200
00100602280	007053	00350303682	009224
00100602480	007060	00350323682	009231
00100602780	007077	00350364182	009248
00100603080	007084	00350414682	009255
00100603280	007091	00350465082	009262
00100603680	007107	00350644082	340006
00100603880	007114	00350660682	009279
00100604180	007121	00350660982	009286
00100604680	007138	00350661382	009293
00100605080	007145	00350661782	009316
00100605580	007152	00350661982	009323
00101000080	007237	00350662282	009347
00101100080	007275	00400026582	009354
00101300080	007282	00350662782	009361
00101500080	007299	00350662882	009378
00101600080	007312	00350663082	009385
00101800080	007329	00350663582	009392
00105000680	007350	00350663782	009408
00105003680	007367	00350664182	009415
00105004180	007374	00350664382	009422
00105004680	007381	00350664682	009439
00105005080	007398	00350665082	009453
00105005580	007404	00350665382	009460
00105006080	007411	00350665582	009477
00105006580	007428	00350665882	009484
00105007080	007435	00350666082	009507
00105007580	007442	00350666482	009514
00105008080	007459	00350666882	009521
00105030080	007466	00350666982	009538
00105034480	007473	00350667482	009545
00105034880	007480	00400070080	009552
00105034780	007497	00350744082	009644
00105035080	007503	00350747082	009651
00105035280	007527	00350747182	163735
00105035580	007534	00350767082	009668
00105035680	007541	00350844082	0094350
00105035880	007558	00350942082	009675
00105036280	007565	00350942182	009682
00105036380	007572	00350942282	009699
00105036780	007596	00350943482	009712
00105040080	007602	00350943582	129199
00105050080	007619	00350944082	009729
00105140080	007626	00350945582	009736
00106000080	007633	00350945682	163377
00300020080	007961	00350947082	009743
00300020082	007978	00350947282	366846
00300020086	007985	00350948082	009750
00300024080	008012	00350948582	009767
00300024082	008029	00350948682	310559
00300024086	008036	00350962082	009774
00313017521	008142	00350962182	009781
00313024021	008166	00350964082	009798
00315024082	008173	00350967082	009804
00315024086	008180	00370524050	009859
00350040582	008265	00370534050	009866
00350055582	008289	00380001380	009880
00350055782	008302	00380001480	009897
00350060782	008333	00380001780	009903
00350080982	008388	00380001980	009910
00350081082	008418	00380002280	009927
00350101182	008456	00380002480	009934
00350101282	008487	00380002780	009941
00350101382	008517	00380003080	009958
00350111382	008548	00380003280	009965
00350121382	008562	00380003680	009989
00350121482	008593	00380004180	009996
00350131482	008616	00380004680	010015
00350131582	008647	00380005080	010039
00350131682	008661	00380005580	010053

Bestell-No. Order-No.	EAN 402 40 89 +	Bestell-No. Order-No.	EAN 402 40 89 +
00380006080	125009	00400728082	011401
00390000437	010084	00400728182	011418
00390000482	010091	00400734082	011425
00390000637	010107	00400737082	011432
00390000682	010114	00400738082	011449
00390000837	010121	00400824082	094374
00390000882	010145	00400827082	094381
00390001037	010152	00400924082	011470
00390001082	010169	00400924382	366853
00390001237	010176	00400925582	011487
00390001282	010183	00400927082	011494
00390001537	010190	00400927282	011524
00390001582	010206	00400927582	366877
00390001837	010213	00400928582	366211
00390001882	010220	00400928882	366228
00392340682	361964	00400928982	011548
00392390882	361971	00400929082	011555
00400005582	010282	00400929582	011562
00400006082	010299	00400929882	011579
00400007082	010312	00400930282	011586
00400008082	010336	00400934082	011593
00400009082	010350	00400935582	011609
00400010082	010381	00400937082	011616
00400011082	010404	00400939082	011623
00400012082	010435	00400939582	011630
00400013082	010466	00410010083	097030
00400014082	010497	00410011083	097047
00400015082	010527	00410012083	097054
00400016082	010558	00410013083	097061
00400017082	010589	00410014083	097078
00400018082	010602	00410015083	097085
00400019082	010633	00410016083	097092
00400020082	010657	00410017083	097108
00400021082	010664	00410018083	097115
00400022082	010695	00410019083	097122
00400023082	010701	00410020083	097139
00400024082	010718	00410021083	097146
00400025082	010725	00410022083	097153
00400026082	010732	00410023083	097160
00400027082	010749	00410027083	097177
00400028082	010756	00410030083	097184
00400029082	010763	00410032083	097191
00400030082	010770	00410034083	097207
00400032082	010787	00410036083	097214
00400034082	010794	00410041083	097221
00400036082	010800	00410945083	100853
00400038082	010817	00410946083	100860
00400041082	010824	00410948583	100877
00400046082	010831	00430111382	011678
00400050082	010848	00430141782	011685
00400055080	010855	00430146282	011692
00400060080	010862	00430192282	011715
00400065080	010879	00450060782	011753
00400070080	010886	00450080982	011760
00400075080	010893	00450081082	011784
00400080080	010909	00450101182	011791
00400627382	340419	00450101382	011821
00400631282	010916	00450121382	011838
00400631682	010923	00450131782	011869
00400631982	010947	00450141582	011876
00400632182	010961	00450141782	011883
00400632382	010985	00450161782	011890
00400632582	011005	00450171982	011937
00400632682	011012	00450181982	011944
00400632782	011029	00450192282	011975
00400632982	011043	00450202282	011982
00400633182	011050	00450212382	011999
00400633282	011067	00450222482	012002
00400633382	011074	00450242682	162684
00400633482	011081	00450242782	012019
00400633582	011098	00450252882	012026
00400633782	011104	00450303282	012033
00400633882	011111	00450364182	012040
00400633982	011128	00450944082	012057
00400634182	011135	00450947082	012064
00400634282	011142	00475055782	012194
00400634382	011159	00475060782	012200
00400634482	011166	00475070882	012217
00400634582	011173	00475080982	012224
00400634782	011180	00475081082	012231
00400634982	011197	00475091182	012248
00400635082	011203	00475101182	012255
00400635282	011210	00475101382	012279
00400635480	011227	00475111382	012286
00400635580	011234	00475121382	012293
00400635680	011241	00475121482	012309
00400635780	011258	00475131482	012316
00400635880	011265	00475131582	012323
00400635980	011272	00475131682	012330
00400724082	011388	00475131782	012347
00400727182	011385	00475141582	012354
00400727282	011395	00475141782	012361

Bestell-No. Order-No.	EAN 402 40 89 +	Bestell-No. Order-No.	EAN 402 40 89 +
00475161782	012378	00497192280	013894
00475161882	012385	00497222480	013900
00475171982	012415	00497242680	170924
00475181982	012422	00497242780	013917
00475182182	012439	00497303280	013924
00475192282	012453	00501242736	013962
00475192482	012477	00501242736	013962
00475202282	012484	00501273236	013979
00475212382	012491	00501273236	013979
00475212482	012507	00503665636	014020
00475222482	012521	00503666436	014037
00475242682	012538	00510101037	014181
00475242782	012552	00510101137	014198
00475243082	012569	00510101237	014204
00475252882	012576	00510101437	014228
00475272982	012583	00510101737	014235
00475273082	012590	00510101937	014259
00475273282	012606	00510102437	014273
00475303282	012620	00510102737	014280
00475303482	012637		

Bestell-No. Order-No.	EAN 402 40 89 +	Bestell-No. Order-No.	EAN 402 40 89 +	Bestell-No. Order-No.	EAN 402 40 89 +	Bestell-No. Order-No.	EAN 402 40 89 +	Bestell-No. Order-No.	EAN 402 40 89 +
0079231180	145380	00808002720	016789	00810637620	017762	00820637220	018813	00895101236	020007
00792311280	145397	00808003020	016796	00810637720	017779	00820637320	018820	00895101336	020014
00792311380	145403	00808003220	016802	00810637820	017786	00820637420	018837	00895101436	020045
00792311480	145410	00808003620	016819	00810637920	017793	00820637520	018844	00895111336	020052
00792311580	145427	00808004120	016826	00810638020	017809	00820637620	018851	00895121336	020069
00792311680	145434	00808004620	016833	00810638120	017816	00820637720	018868	00895121436	020076
00792311780	145441	00808005020	016840	00810638220	017823	00820637820	018875	00895131436	020083
00792311880	145458	00808005520	016857	00810638320	017830	00820637920	018882	00895131536	020090
00792311980	145465	00808006020	016864	00810638420	017847	00820638020	018899	00895131736	020106
00792410880	144970	00808006520	016871	00810638520	017854	00820638120	018905	00895141536	020113
00792411080	144987	00810002420	016949	00810639020	017861	00820638220	018912	00895141736	020120
00792411180	144994	00810002720	016956	00810639520	017878	00820638320	018929	00895161736	020137
00792411280	144999	00810003020	016963	00810639620	017885	00820638420	018936	00895161836	020144
00792411380	145007	00810003220	016970	00810639720	017892	00820638520	018943	00895171936	020151
00792411480	145014	00810003620	016987	00820002420	018028	00820638620	018950	00895172136	020168
00792411580	145021	00810003820	016994	00820002720	018035	00820638720	018967	00895172236	020175
00792411680	145038	00810004120	017007	00820003020	018042	00820638820	018974	00895192236	020182
00792411780	145045	00810004620	017014	00820003220	018059	00820638920	018981	00895192436	020199
00792411880	145052	00810005020	017021	00820003620	018066	00820639020	018998	00895212336	020205
00792411980	145069	00810005520	017038	00820003820	018073	00820639520	019001	00895222436	020212
00792412180	145076	00810006020	017045	00820004120	018080	00820639620	019018	00895222736	020229
00792412280	145083	00810006520	017052	00820004620	018097	00820639720	019025	00895242736	020236
00792511080	144963	00810007020	017069	00820005020	018103	00840002280	019209	00895242936	020243
00792511180	144956	00810007520	017076	00820005520	018110	00840002480	019216	00895243036	020250
00792511280	144949	00810008020	017083	00820006020	018127	00840002780	019223	00895273236	020267
00792511380	144932	00810008520	017090	00820006520	018134	00840003080	019230	00895303236	020274
00792511480	144925	00810009020	017106	00820007020	018141	00840003380	019247	00895303636	020281
00792511680	144918	00810009520	017113	00820007520	018158	00840003680	019254	00895323636	020298
00792511780	144901	00810010020	017120	00820008020	018165	00840004180	019261	00895364136	020304
00792511880	144895	00810010520	017137	00820008520	018172	00840004680	019278	00895414636	020311
00792511980	144888	00810011020	017144	00820009020	018189	00840005080	019285	00895465036	020328
00792512180	144871	00810011520	017151	00820009520	018196	00840005580	019292	00895505536	020335
00792512280	144864	00810012020	017168	00820010020	018202	00840006080	019308	00895556036	020342
00794000080	136623	00810012520	017175	00820010520	018219	00840006580	019315	00895657020	020359
00794100083	147247	00810013020	017182	00820011020	018226	00840007080	019322	00895758020	020397
00794210080	145502	00810013520	017199	00820011520	018233	00840007580	019339	00895942036	020403
00794311380	145236	00810014020	017205	00820012020	018240	00840008080	019346	00895942136	020410
00794311480	143256	00810014520	017212	00820012520	018257	00840008580	019353	00895942236	020427
00794311580	145243	00810015020	017229	00820013020	018264	00840009080	019360	00895944036	020434
00794311680	145250	00810015520	017236	00820013520	018271	00840009580	019377	00895947036	020441
00794311780	143249	00810016020	017243	00820014020	018288	00840010080	019384	008960060780	099201
00794311880	145267	00810016520	017250	00820014520	018295	00845000060	146349	00896080980	099218
00794311980	143232	00810017020	017267	00820015020	018301	00845000160	146356	00896081080	099225
00794312180	145274	00810017520	017274	00820015520	018318	00845000260	146363	00896101180	020458
00794312280	145281	00810018020	017281	00820016020	018325	00845000360	146370	00896121380	099249
00794312480	145298	00810018520	017298	00820016520	018332	00894006036	019537	00896141580	099263
00794312780	145304	00810019020	017304	00820017020	018349	00894007036	019544	00896161780	099287
00794313080	145311	00810019520	017311	00820017520	018356	00894008036	019551	00896171980	099294
00794313280	145328	00810020020	017328	00820018020	018363	00894009036	019568	00896181980	099300
00794313480	145335	00810021020	017335	00820018520	018370	00894010036	019575	00896202280	099317
00794411380	145090	00810022020	017342	00820019020	018387	00894011036	019582	00896212380	099324
00794411480	145106	00810023020	017359	00820019520	018394	00894012036	019599	00896242680	099348
00794411580	145113	00810633420	017366	00820020020	018400	00894013036	019605	00896242780	099355
00794411680	145120	00810633720	017373	00820020520	018417	00894014036	019612	00896252880	099362
00794411780	145137	00810633820	017380	00820021020	018424	00894015036	019629	00896303280	099393
00794411880	145144	00810633920	017397	00820021520	018431	00894017036	019636	00896323680	099416
00794411980	145151	00810634020	017403	00820022020	018448	00894018036	019643	00896364180	099423
00794412180	145168	00810634120	017410	00820022520	018462	00894019036	019650	00896414680	099430
00794412280	145175	00810634220	017427	00820023020	018479	00894022036	019667	00896465080	099447
00794412480	145182	00810634320	017434	00820023520	018486	00894024036	019674	00896505580	099454
00794412780	145199	00810634420	017441	00820024020	018493	00894027036	019681	00896556080	099461
00794413080	145205	00810634520	017458	00820024520	018509	00894030036	019698	00896744080	356274
00794413280	145212	00810634620	017465	00820025020	018516	00894032036	019704	00896944080	099782
00794413480	145229	00810634720	017472	00820025520	018523	00894036036	019711	00896947080	099799
00795000080	136630	00810634820	017489	00820026020	018530	00894038036	019728	0900000305	020502
00795200080	145526	00810634920	017496	00820026520	018547	00894041036	019735	0900000405	020519
00796000080	136647	00810635020	017502	00820027020	018554	00894044036	019742	0900000505	020526
00800001230	016321	00810635120	017519	00820027520	018561	00894050036	019759	0900000605	020540
00800001630	016338	00810635220	017526	00820028020	018578	00894055036	019766	0900000805	020564
00800002530	016345	00810635320	017533	00820028520	018585	00894060036	019773	0900001005	020588
00800003030	016352	00810635420	017540	00820029020	018592	00894065036	019780	0900001205	020601
00800003430	016369	00810635520	017557	00820029520	018608	00894070036	019797	0900001405	020625
00800004030	016376	00810635620	017564	00820030020	018615	00894075036	019803	0900001605	020656
00800004530	016383	00810635720	017571	00820030520	018622	00894080020	019810	0900001805	020670
00800005230	016390	00810635820	017588	00820031020	018639	00894085020	019827	0900002005	020694
00800005830	016406	00810635920	017595	00820031520	018646	00894090020	019834	0910000282	020762
00800006830	016413	00810636020	017601	00820032020	018653	00894095020	019841	0910000382	020779
00800008030	016420	00810636120	017618	00820032520	018660	00894100020	019858	0910000482	020786
00800009530	016437	00810636220	017625	00820033020	018677	00894105020	019865	0910000582	020793
00800011030	016444	00810636320	017632	00820033520	018684	00894110020	019872	0933000282	021028
00800012030	016451	00810636420	017649	00820034020	018691	00894115020	019889	0933000382	021035
00800013530	016468	00810636520	017656	00820034520	018707	00894120020	019896	0942000282	021134
00800015530	016475	00810636620	017663	00820035020	018714	00894125020	019902	0942000382	021141
00800018030	016482	00810636720	017670	00820035520	018721	00894130020	019919	0943000282	021158
00800020530	016499	00810636820	017687	00820036020	018738	00894135020	019926	0943000382	021165
00800023030	016505	00810636920	017694	00820036520	018745	00895060736	019933	09660001080	141337
00808001320	016727	00810637020	017700	00820037020	018752	00895070836	019940	09660001080	141351

Bestell-No. Order-No.	EAN 402 40 89 +	Bestell-No. Order-No.	EAN 402 40 89 +	Bestell-No. Order-No.	EAN 402 40 89 +	Bestell-No. Order-No.	EAN 402 40 89 +	Bestell-No. Order-No.	EAN 402 40 89 +		
01200020087	146875	01261500200	376135	01340623030	026504	01411003033	028188	01495000380	371444	01577010300	387124
01200020088	146813	01261510000	376173	01340630130	026511	01411003080	028195	01496000250	029369	01577010400	387131
01206016086	023411	01261600000	376111	01340630230	026535	01411004080	028201	01497000050	029376	01577011500	387148
01206016087	146561	01261600200	376142	01340630330	026559	01412000080	028218	01500030080	029383	01577011600	387155
01206016088	146554	01261610000	376180	01340630430	026573	01412000180	028225	01500040080	029406	01577040000	387001
01207016086	023459	01262000100	376333	01340630530	026580	01412000280	028232	01500050080	029413	01577050000	387018
01207016087	146585	01262001000	376319	01340630730	026603	01412001080	028249	01500060080	029420	01577060000	387025
01207016088	146578	01262025000	376302	01340630830	026627	01412002080	028256	01500040080	029437	01577080000	387032
01208014086	146738	01262240100	376296	01340631030	026641	01412003080	028263	01505050080	029444	01577100000	387049
01208014087	146707	01262320100	376289	01340631230	026665	01412004080	028270	01505060080	029451	01578010200	387162
01208016086	146721	01262400100	376272	01340631430	026689	01415000680	028287	01509045020	029468	01578010300	387179
01208016087	146691	01262480100	376265	01340631630	026702	01415000780	028294	01509060020	029475	01578010400	387186
01208016088	146714	01262420200	376258	01340631930	026726	01415000880	028300	01513000000	375732	01578011500	387193
01208020086	023565	01262320200	376241	01340632130	026740	01415000980	028317	01520020021	029499	01578011600	387209
01208020087	146684	01262400200	376234	01340632330	026764	01415001080	028324	01520030021	029505	01605000020	030419
01208020088	023572	01262480200	376227	01340632530	026788	01415001580	028331	01520040021	029512	01610000080	030433
01209020086	023619	01280017520	371550	01340632730	026801	01415002080	028348	01520050021	029529	01615030000	030457
01209020087	146806	01280017550	024937	01340633130	026825	01415002580	028355	01520080021	029536	01616030000	030464
01209020088	023626	01280025020	371567	01340637030	026849	01415002780	028362	01520100021	029543	01617030000	030471
01212014086	146776	01280025050	024944	01340638030	026856	01415003080	028379	01520200021	029567	01621000132	030488
01212014087	146769	01280030020	371574	01340725530	026863	01415004080	028386	01522050011	029581	01621000232	030495
01212016086	146783	01280030050	024951	01340727030	026870	01415004580	028393	01522075011	029598	01621000332	371888
01212016087	146752	01281017550	024968	01340735530	026894	01417011050	100846	01522100111	029604	01622000132	371871
01212020086	023831	01281025050	024982	01340737030	026900	01419000045	028423	01522150011	029628	01622000232	371864
01212020087	146745	01282025050	024999	01340825030	099720	01420000050	028430	01522200011	029635	01626025025	030563
01213012586	146639	01285028050	025026	01341002030	027051	01424000050	028461	01530002500	029680	01640000020	371956
01213012587	146660	01286000420	371611	01341002530	027068	01425000050	028485	01530003000	029697	01640100000	371925
01213014086	146622	01286023520	371604	01341003030	027075	01426000000	028492	01530003500	029703	01641000020	371949
01213014087	146653	01286113520	371628	01341004030	027082	01427000000	028508	01530004000	029710	01641100000	371918
01213014088	146615	01287002420	371598	01341005030	027099	01430010080	028539	01530005000	029734	01642000020	371963
01213016086	023930	01287009220	371581	01341006030	027105	01430012580	028546	01531002500	029758	01642100000	371901
01213016087	146646	01327023054	025644	01341007030	027112	01430015080	028553	01531003000	029765	01643000020	371932
01213016088	146608	01327028080	025651	01341008030	027129	01430020080	028560	01531003500	029772	01643100000	371895
01213018088	146592	01328100000	025668	01341009030	027136	01430025080	028577	01531004000	029789	01646000121	030952
01215016086	023985	01328200000	025675	01341010030	027143	01430030080	028584	01531005000	029802	01656014560	031157
01215016087	146790	01329000354	025705	01341012030	027150	01435006080	028591	01540000100	029833	01659030000	387056
01220016086	024081	01329000454	025712	01341014030	027167	01435007580	028607	01550000021	029888	01659035000	387063
01220016088	024098	01330001020	025729	01341017030	027174	01435010080	028614	01551000021	029895	01659035100	387070
01230021550	024159	01330001520	025736	01341019030	027181	01435012580	028621	01555012521	029932	01659120200	387087
01231034055	145847	01330002020	025743	01343825030	099768	01435015080	028638	01555015021	029949	01659125200	387094
01232027500	374667	01330003020	025750	01345000530	027303	01435017580	028645	01555017521	029963	01659130200	387100
01233025080	375671	01330001020	025767	01345000630	027310	01435020080	028652	01555020021	029970	01660020021	031188
01250017513	147070	01333001520	025774	01345000830	027327	01436006085	028669	01555025021	029987	01660025021	031195
01250017587	147124	01333002020	025781	01345001030	027334	01436007533	028676	01555030021	029994	01661020021	031225
01250022013	147063	01333003020	025798	01345001230	027341	01436007585	028683	01555125000	030006	01661025021	031232
01250022087	147117	01335002580	113174	01345001430	027358	01436010033	028690	01555130000	030013	01662020021	031263
01250030013	147056	01335003080	113167	01345001630	027365	01436010085	028706	01556012521	386677	01662025021	031270
01250030087	147100	01335004080	113150	01345723030	027396	01436010133	028713	01556015021	386714	01663020021	031300
01250114013	147094	01335005080	113143	01347000680	110333	01436012533	028720	01556017521	386721	01663025021	031317
01250214013	147087	01335006080	113136	01347000780	110340	01436012585	028737	01556020021	386738	01664000000	329018
01250214087	147131	01335008080	113129	01347000880	110357	01436015033	028744	01557023021	030020	01664000200	334654
01252016513	147209	01335010080	113112	01347000980	110364	01436015085	028751	01557123000	030037	01664000300	367546
01252016587	147162	01335727280	347296	01347001080	110371	01436017533	028768	01558250021	386844	01664001200	331554
01252020513	147193	01337002580	100242	01347001580	110388	01436017585	028775	01558125000	030051	01664021200	334647
01252020587	147155	01337003080	100259	01347002080	110395	01436020085	028782	01560012521	030075	01664030800	367553
01252027513	147186	01337003580	100266	01347002580	110401	01437010080	028799	01560015021	030082	01664101000	329025
01252027587	147148	01337004080	100273	01347002780	110418	01437012580	028805	01560017521	030099	01664201000	334661
01252113013	147223	01337004580	100280	01347003080	110425	01437015080	028812	01560020021	030105	01664301000	367560
01252213013	147216	01337005080	100297	01347004080	110432	01437017580	028829	01560025021	030112	01665028060	031324
01252213087	147179	01337006080	100303	01347004580	110449	01437020080	028836	01560125000	386660	01667028060	031362
01255018013	147339	01337007080	100310	01347722080	347302	01437025080	028843	01561012521	386745	01668000000	031379
01255018087	147292	01337008080	100327	01348000630	027532	01445004080	028881	01561015021	386752	01669000000	353365
01255023013	147322	01337010080	100334	01348000730	027549	01445006080	028898	01561017521	386769	01670000011	031393
01255023087	147285	01337722080	110722	01348000830	027556	01450000033	028911	01561020021	386776	01670000261	031409
01255031013	147315	01340001030	025873	01348000930	027563	01452000080	028928	01562000100	030150	01675020000	031454
01255031087	147278	01340001530	025880	01348001030	027570	01454000080	028935	01563020021	386783	01675025000	031461
01255114513	147353	01340002030	025903	01348001530	027587	01456000080	028942	01563025021	386790	01676020000	031492
01255214513	147346	01340002530	025927	01348002030	027594	01458000080	028959	01563030021	386806	01676025000	031508
01255214587	147308	01340003030	025941	01348002530	027600	01460000080	028966	01563040021	386813	01677020000	031539
01256017013	147421	01340003530	025965	01348002730	027617	01470007580	029017	01563130000	386820	01677025000	031546
01256017087	147384	01340004030	025989	01348003030	027624	01470009080	029024	01563140000	386837	01678020000	031577
01256021513	147414	01340004530	026016	01348004030	027631	01470010080	029031	01565000221	030174	01678025000	031584
01256021587	147377	01340005030	026030	01348004530	027648	01470012580	029048	01565000321	030181		

Bestell-No. Order-No.	EAN 402 40 89 +	Bestell-No. Order-No.	EAN 402 40 89 +	Bestell-No. Order-No.	EAN 402 40 89 +	Bestell-No. Order-No.	EAN 402 40 89 +	Bestell-No. Order-No.	EAN 402 40 89 +
01755000300	032048	03310000000	034813	04511003080	165531	06300181736	396034	06500312236	396676
01755000400	032055	03700000636	087253	04511004080	165593	06300181936	396041	06501001036	037289
01759000300	032093	03700000736	101676	04512000080	165807	06300182136	396058	06501001336	037296
01781002500	032116	03700000836	101683	04512000180	165821	06300182236	396065	06501001436	037302
01782025000	032130	03700000936	101690	04512000280	165814	06300191036	036800	06501001536	037319
01783030020	162745	03700001036	101706	04512001080	165791	06300191336	036817	06501002036	037326
01790000120	032161	03700001136	101713	04512002080	165784	06300191436	036824	06501002236	037340
01805024000	378375	03700001236	101720	04512003080	165777	06300191636	036831	06501004000	037357
01806015080	032192	03700001336	101737	04515000680	165760	06300191736	036848	06501004136	037364
01807015080	359954	03700001436	101744	04515000780	165753	06300191836	036855	06600001936	037517
01814000240	032215	03700001536	101751	04515000880	165746	06300191936	036862	06600002236	037524
01814000340	032222	03700001636	101768	04515000980	165739	06300192136	036879	06600002436	037531
01814000440	032239	03700001736	101775	04515001080	165722	06300192236	036886	06600002736	037548
01814001240	032253	03700001836	101782	04515002780	165715	06300192436	036893	06600002936	037555
01814001340	032260	03700001936	101799	04515002080	165708	06300192736	036909	06600003036	037562
01815007500	380392	03700002036	101805	04515002580	165692	06300193036	396010	06600003236	037579
01836030000	032604	03700002136	101812	04515002780	165685	06300193236	396027	06600003336	037586
01837020000	377569	03700002236	101829	04515003080	165678	06300201036	396157	06600003636	037593
01839300000	032628	03700190736	101836	04515004080	165661	06300201236	396171	06600003836	037609
018400051200	331561	03700190836	101843	04530010080	165470	06300201436	396195	06600004136	037623
01840081200	367256	03700190936	101850	04530012580	165463	06300201636	396201	06600004636	037630
01840500000	329032	03700191036	101867	04530015080	165456	06300201836	396218	06600005036	037647
01840800000	367263	03700191136	101874	04530020080	165449	06300202036	396225	06600005536	037654
01842025030	032635	03700191236	101881	04530025080	165432	06300202436	396232	06600006036	037661
01856000383	032734	03700191336	101898	04530030080	165425	06300310236	396072	06600006536	037678
01856000483	032741	03700191436	101904	04535000680	165302	06300310336	396089	06600003736	396737
01857000000	358667	03700191536	101911	04535007580	165319	06300310436	396096	06600004136	396744
01905000000	032758	03700191636	101928	04535010080	165326	06300310536	396102	06600004436	396751
01920100000	032819	03700191736	101935	04535012580	165333	06300310636	396119	06600004536	396768
02010000300	381764	03700191836	101942	04535015080	165340	06300310736	396126	06600004736	396775
02010000800	372014	03700191936	101959	04535020080	165357	06300310836	396133	06600005036	396782
02010001000	372007	03700192036	101966	04536007533	165289	06300310936	396140	06600005136	396799
02011000000	372496	03700192136	101973	04536010033	165272	06300363036	396249	06600005636	396805
02012000000	372502	03700192236	101980	04536010133	165265	06300364036	396256	06600192236	037692
02014002280	380095	03704001536	103618	04536012533	165258	06300364536	396263	06600192436	037708
02015000080	382075	03704002536	103625	04536015033	165241	06300365036	396270	06600192736	037715
02015050080	381481	03705005036	103632	04537010080	165371	06300367036	396287	06600193036	037722
02015201080	381375	03706001036	126310	04537012580	165388	06300366036	396294	06600193236	037739
02015201280	381382	03800001036	095623	04537015080	165395	06300901136	366518	06600193336	037746
02015201480	381399	03800001136	095630	04537017580	165401	06301001036	036916	06600193636	037753
02015201680	381405	03800001236	095647	04537020080	165418	06301001136	036923	06600193836	037760
02015201880	381412	03800001336	095654	04537025080	165364	06301001236	036930	06600194136	037784
02015301280	381443	03800001436	095661	04545004080	165494	06301001336	036947	06600194636	037791
02015301380	381450	03800001536	095678	04545006080	165487	06301001436	036954	06600195036	037807
02015301680	381467	03800001636	095685	04550000033	166521	06301002036	036961	06600195536	037814
02015301880	381474	03800001736	095692	04560000080	167702	06301002236	036978	06600196036	037821
02145000000	033021	03800001836	095708	04561000080	359107	06301104000	036992	06600310936	396829
02165003200	033236	03800001936	095715	04562000080	359114	06301104136	037005	06600312036	396836
02165003500	033243	03800002036	095722	04563000080	359121	06301204000	037012	06600312136	396843
02165004000	033250	03800002136	095739	04564000080	166507	06301204136	037029	06600312236	396850
02165005500	033267	03800002236	095746	04565000080	166514	06500001736	037050	06600312336	396867
02166003200	033304	03800002336	095753	04566000080	359138	06500001936	037067	06600312436	396874
02166003500	033311	03800002436	095760	04567000080	166491	06500002236	037074	06600312536	396881
02166004000	033328	03800002536	095777	06101003080	118452	06500002436	037081	06601001336	037883
02166005000	033335	03800002636	095784	06201003080	036589	06500002736	037098	06601001436	037890
02199004045	113990	03800002736	095791	06300000836	036602	06500003036	037104	06601001536	037906
02240001060	033779	03800002836	095807	06300001036	036619	06500003236	037111	06601002036	037920
02240002060	033786	03800002936	095814	06300001136	036626	06500003336	037128	06601004000	037944
02240003060	033793	03800003036	095821	06300001236	036633	06500003636	037135	06601004136	037951
02240004060	033809	03800003236	095845	06300001336	036640	06500003836	037142	08490009500	388053
02240005060	033816	03800191036	101997	06300001436	036657	06500004136	037159	91129800120	328943
02240006060	033823	03800191136	102000	06300001536	036664	06500004636	037166	91129800220	328936
02243001060	033915	03800191236	102017	06300001636	036671	06500003436	396324	91129800360	327274
02243002060	033922	03800191336	102024	06300001736	036688	06300033536	395907	91129800460	328912
02243003060	033939	03800191436	102031	06300001836	036695	06500033736	396348	91129800560	328882
02243004060	033946	03800191536	102048	06300001936	036701	06500033836	396355	91129800620	328929
02243005060	033953	03800191636	102055	06300002036	036718	06500033936	396362	91129800720	328899
02243006060	033960	03800191736	102062	06300002136	036725	06500034136	396379	91129800820	328905
02243007070	033977	03800191836	102079	06300002236	036732	06500034236	396386	91129801220	330533
02246000060	034073	03800191936	102086	06300002336	036749	06500034336	396393	91512028000	327120
02252000160	034080	03800192036	102093	06300002436	036756	06500034436	396409	98710251600	365276
02252000260	034097	03800192136	102109	06300002536	036763	06500034536	396416	98710401600	365283
02253000160	034103	03800192236	102116	06300002636	036770	06500034736	396423	98710501600	365290
02253000260	034110	03800192336	102123	06300002736	036787	06500034836	396430	06600003336	037586
02255000060	034127	03800192436	102130	06300003036	036794	06500034936	396447	06600003636	037593
02255000160	034134	03800901536	366501	06300003236	395969	06500035236	396454	06600003836	037609
02255000260	034141	03804002536	103649	06300003336	395976	06500035136	396461	06600004136	037623
02255000360	034158	03804005036	103656	06300003436	395983	06500191936	037173	06600004636	037630
02256000060	034202	03805005036	103663	063000032136	395822	06500192236	037180	06600005036	037647
02256000160	034219	03806001036	107371	06300003236	395839	06500192436	037197	06600005536	037654
02256000260	034226	04500000000	166446	063000032536	395846	06500192736	037203	06600006036	037661
02256000360	034233	04500010000	166408	063000032736	395853	06500193036	037210	06600006536	037678
02256000460	034240	04501000000	166453	063000032936	395860	06500193236	037227	06600192236	037692
02256000560	034257	04502000000	166460	063000033136	395877	06500193336	037234	06600192436	037708
02256003160	034271	04511000080	165562	063000033336	395884	06500193436	037241	06600192736	037715
02257000480	371987	04511000180	165586	063000033436	395891	06500193636	037258	06600193036	037722
02257000780	371970	04511000280	165579	063000033536	395907	06500194136	037265	0	

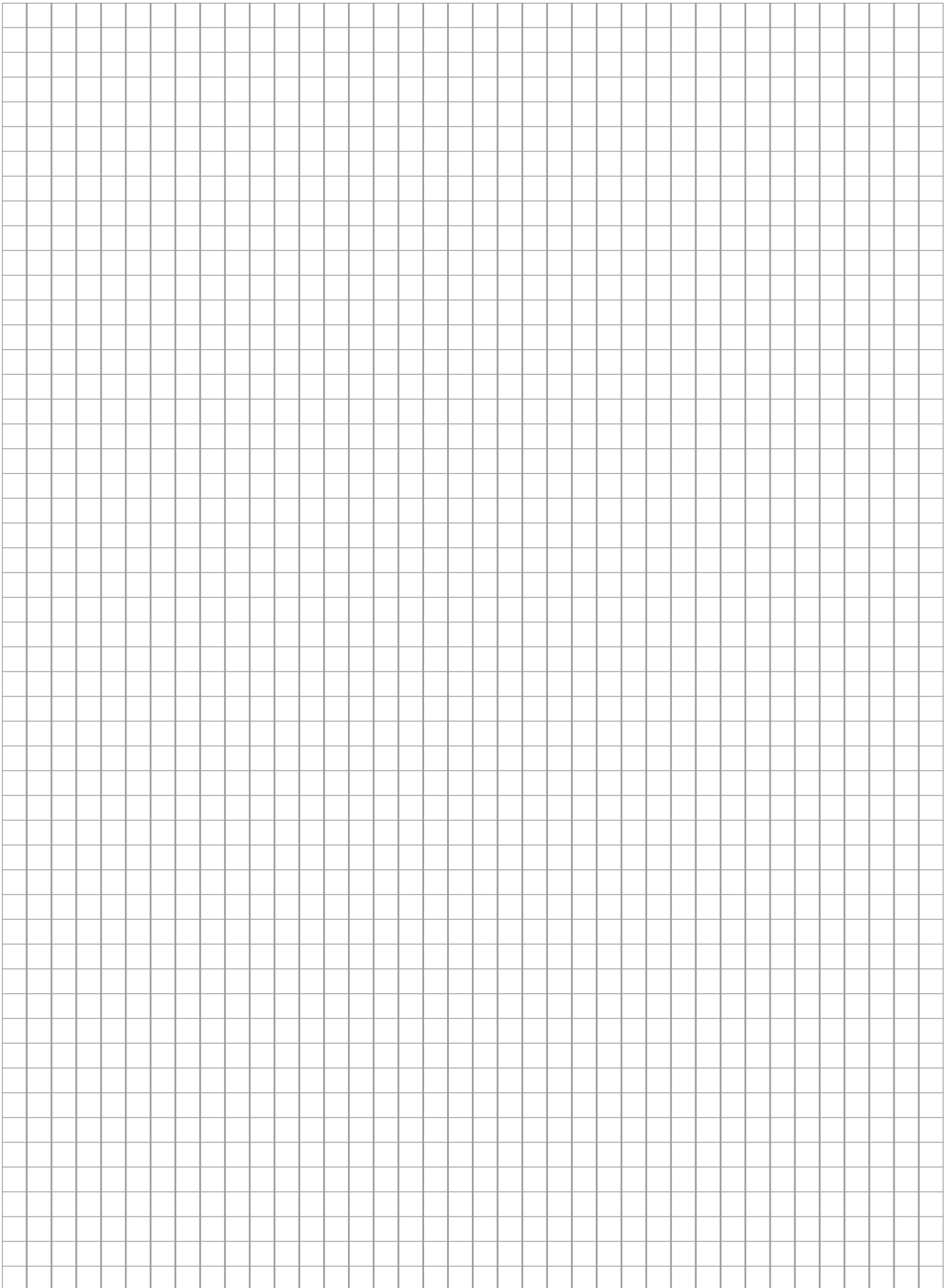



QUALITY TOOLS



PRECISION MOULDINGS



TECHNICAL PLASTIC PRODUCTS



IN MOULD DECORATION